

Proximity Sensors

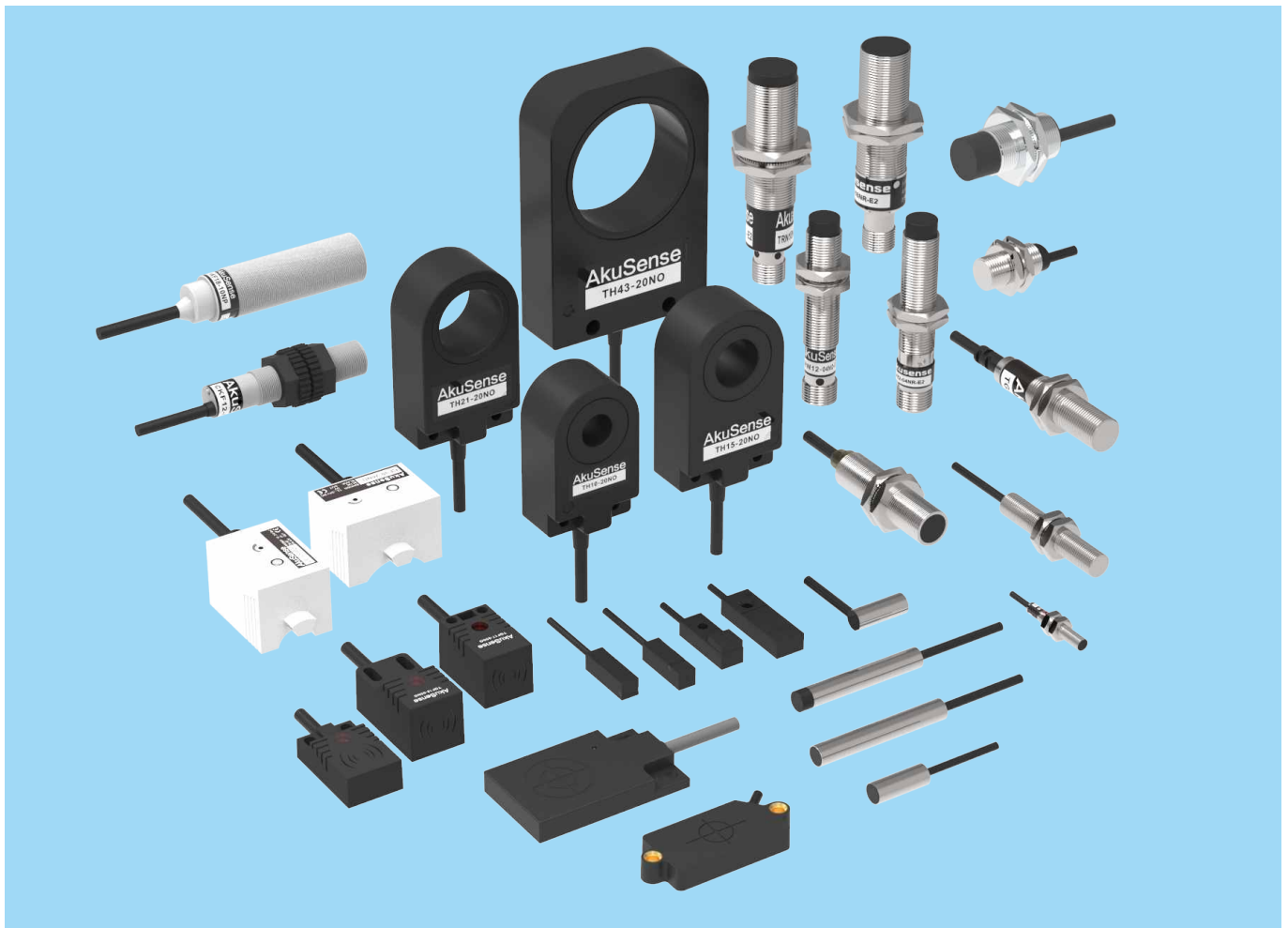

- ⦿ Non-contact position detection, wear-free and highly reliable.
- ⦿ Highly sensitive and intense accuracy, durability up to 8 years.
- ⦿ A full range of housing materials: stainless steel, nickel-copper alloy, plastic and Teflon coating.
- ⦿ Covering a wide range of specifications and sizes
- ⦿ IP67 protection design, excellent water and oil resistance.



Standard Distance Type (TR series)

- Classical cylindrical appearance, high stability
- Adaptive to different occasions, top-notch quality, low price
- Customizable cables & connectors as requested

P.E-17



Extended Distance Type (TL series)

- sensing distance is double that of standard products
- Save installing space effectively
- Customizable cables & connectors at your request

P.E-20



Long Distance Type (TY series)

- Ultra-long sensing distance, up to 40mm
- Avoid any attenuation caused by the material of detected objects
- Ip67 high protection degree

P.E-23



Square Type (TQ series)

- Kidney-shaped hole, easy installation
- Up to 8 mm sensing distance
- Plastic housing, protection degree IP67

P.E-26

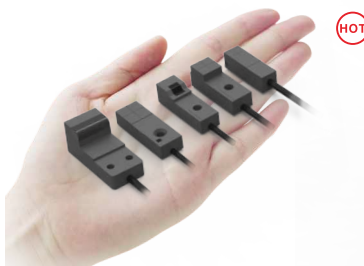

Mini-square Type (TE series)

- 6mm (extra small), built-in amplifier
- 8mm sensing distance, the longest sensing distance in the industry
- Sensing surface on the top and at the front to suit your needs

P.E-27



Mini-cylindrical Type (TX series)

- Highly stabilized detection in narrow space
- Shield type, can be embedded in detecting objects
- $\Phi 3, \Phi 4, M4, M5$, various models for you to choose from

P.E-29

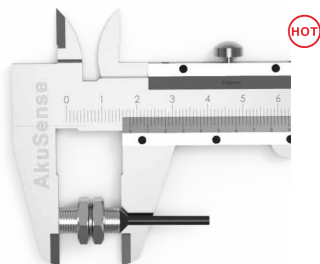

Short-body Type (TSS/TS series)

- Compared with similar sensors, the length can be shortened 1/3
- 18mm body length can perfectly fit into narrow space
- Epoxy resin fillings exhibit excellent shock resistance

P.E-31



Ring-type (TH series)

- 2mm thickness, the thinnest one in the industry
- Stainless steel casing; strong impact resistance
- Flexible sensitivity adjustment with knobs

P.E-34



Metal Face Type (TM series)

- Stainless steel face, with great impact resistance
- 1000PSI/High pressure resistance
- Wonderful thermal shock and chemical resistance

P.E-35



Temperature Resistance Type (TG/TZ series)

- Extended temperature varies from -40°C to $+220^{\circ}\text{C}$
- Degree of protection up to IP67
- Reverse polarity protection and surge protection

P.E-37



IP69K High Protection (TP series)

- AISI 316L stainless steel housing
- IP67-IP68-IP69K protection level
- Can be used in the food and beverage field

P.E-39

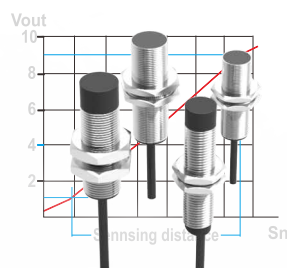

Analog Output Type (TA series)

- First choice of short distance and non-contact detection
- Analog output 0~20mA and 0~10V
- Output PNP-Analog

P.E-41

- Fiber Optic
- Slot Sensors
- Photoelectric
- Laser
- Proximity**
- Displacement
- Magnetic
- Contact
- Area
- Ultrasonic
- Vision
- Code Readers
- Vibration
- Temperature
- Accessories

Guidance

Inductive sensors

- Standard distance
- Extended distance
- Long distance
- Square
- Mini square
- Mini-cylindrical
- Short-body
- Ring-type
- Metal face
- Temperature
- IP69K high protection
- Analog output
- DC 2 wires

Capacitive sensors

- Cylindrical
- Correction resistanc type
- Flat type
- Level detection



DC 2-wire Type (TD series)

- Nonpolarized specifications, easy wiring method
- With smallest sensing surface M8
- 10~30V DC and 10~60V DC ,two voltages

P.E-42



Cylindrical Type (CK series)

- Detect metal, plastic and liquid, ect
- With reverse polarity, short circuit, surge and many other protection functions
- Metal and plastic housings are available

P.E-44



Corrosion Resistant Type (CWF series)

- Up to 20 turns sensitivity adjustment
- Teflon coatings ensure superior corrosion resistance
- Widely used in detection of metals, water, oil, glasses, plastic and water, etc

P.E-45



Flat Type (CQ series)

- 7mm of thickness only for saving space
- Enjoy stability; comparable to world famous brands
- Offer different kinds of sensing distance of 5mm, 6mm, 7mm and 10mm, etc

P.E-46



(HOT)

Liquid Level Detection (CE series)

- Free from influence of liquid color in pipeline
- Suitable for pipeline diameter from Φ 8mm to Φ 11mm, Φ 12mm to Φ 26 mm
- With built-in amplifier to save installing space

P.E-48

- Fiber Optic
- Slot Sensors
- Photoelectric
- Laser
- Proximity**
- Displacement
- Magnetic
- Contact
- Area
- Ultrasonic
- Vision
- Code Readers
- Vibration
- Temperature
- Accessories

Guidance

Inductive sensors

- Standard distance
- Extended distance
- Long distance
- Square
- Mini square
- Mini-cylindrical
- Short-body
- Ring-type
- Metal face
- Temperature
- IP69K high protection
- Analog output
- DC 2 wires

Capacitive sensors

- Cylindrical
- Corrosion resistant type
- Flat type
- Level detection

Type 1	Type 2	Series	
Inductive Sensors	Cylindrical	Standard Distance	TR Series
		Extended Distance	TL Series
		Long Distance	TY Series
		Mini-cylindrical	TX Series
		Short-body	TSS/TS Series
		Analog Output	TA Series
		DC 2-wire	TD Series
	Square	Standard Square	TQ Series
		Mini-square	TE Series
		Ring-type	TH Series
	Special Applications	Metal Face	TM Series
		Temperature Resistance	TG/TZ Series
		IP69K High Protection	TP Series
Capacitive Sensors	Cylindrical	Plastic Shells	CK Series
	Corrosion Resistant	Teflon Shells	CWF Series
	Flat	Plastic Shells	CQ Series
	Special Applications	Liquid Level Detecion	CE Series

- Fiber Optic
- Slot Sensors
- Photoelectric
- Laser
- Proximity**
- Displacement
- Magnetic
- Contact
- Area
- Ultrasonic
- Vision
- Code Readers
- Vibration
- Temperature
- Accessories

Guidance

Inductive sensors

- Standard distance
- Extended distance
- Long distance
- Square
- Mini square
- Mini-cylindrical
- Short-body
- Ring-type
- Metal face
- Temperature
- IP69K high protection
- Analog output
- DC 2 wires

Capacitive sensors

- Cylindrical
- Corrosion resistant type
- Flat type
- Level detection

Standard Distance DC 3-wire

Type	Appearance	Sensing distance		Model numbers		Pages	
		Unit: mm		NPN Normally open	NPN Normally closed		
Pre-wired Type	Shielded		$\phi 6.5 \times 45.5$	1.5mm	TRF6.5-1.5NO	TRF6.5-1.5NC	E-17
			M8*45	1.5mm	TRF08-1.5NO	TRF08-1.5NC	
			M12*44.5	2mm	TRF12-02NO	TRF12-02NC	
			M18*55	5mm	TRF18-05NO	TRF18-05NC	
			M30*54	10mm	TRF30-10NO	TRF30-10NC	
	Unshielded		$\phi 6.5 \times 45$	2mm	TRN6.5-02NO	TRN6.5-02NC	
			M8*45.5	2mm	TRN08-02NO HOT	TRN08-02NC	
			M12*46.5	4mm	TRN12-04NO HOT	TRN12-04NC	
			M18*54	8mm	TRN18-08NO	TRN18-08NC	
			M30*58	15mm	TRN30-15NO	TRN30-15NC	
Connector Type	Shielded		M8*60	1.5mm	TRF08-1.5NO-E1	TRF08-1.5NC-E1	
			M12*68	2mm	TRF12-02NO-E2	TRF12-02NC-E2	
			M18*82	5mm	TRF18-05NO-E2	TRF18-05NC-E2	
			M30*78	10mm	TRF30-10NO-E2	TRF30-10NC-E2	
			M8*60	2mm	TRN08-02NO-E1	TRN08-02NC-E1	
	Unshielded		M12*67	4mm	TRN12-04NO-E2	TRN12-04NC-E2	
			M18*78	8mm	TRN18-08NO-E2	TRN18-08NC-E2	
			M30*78	15mm	TRN30-15NO-E2	TRN30-15NC-E2	

Noted: Model numbers ended with "PO"/"PO-E1"/"PO-E2" are PNP normally open ; model numbers ended with "PC"/"PC-E1"/"PC-E2" are PNP normally closed.

Extended Distance DC 3-wire

















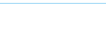

Type	Appearance	Sensing distance		Model numbers		Pages	
		Unit: mm		NPN Normally open	NPN Normally closed		
Pre-wired Type	Shielded		$\phi 6.5 \times 45$	2mm	TLF6.5-02NO	TLF6.5-02NC	E-20
			M8*45	2mm	TLF08-02NO	TLF08-02NC	
			M12*45	4mm	TLF12-04NO	TLF12-04NC	
			M18*54	8mm	TLF18-08NO	TLF18-08NC	
			M30*54	16mm	TLF30-16NO	TLF30-16NC	
	Unshielded		$\phi 6.5 \times 44$	4mm	TLN6.5-04NO	TLN6.5-04NC	
			M8*44	4mm	TLN08-04NO HOT	TLN08-04NC	
			M12*53	8mm	TLN12-08NO HOT	TLN12-08NC	
			M18*58	16mm	TLN18-16NO	TLN18-16NC	
			M30*61	25mm	TLN30-25NO	TLN30-25NC	
Connector Type	Shielded		M8*60	2mm	TLF08-02NO-E1	TLF08-02NC-E1	
			M12*68	4mm	TLF12-04NO-E2	TLF12-04NC-E2	
			M18*82	8mm	TLF18-08NO-E2	TLF18-08NC-E2	
			M30*78	16mm	TLF30-16NO-E2	TLF30-16NC-E2	
			M8*60	4mm	TLN08-04NO-E1	TLN08-04NC-E1	
	Unshielded		M12*71	8mm	TLN12-08NO-E2	TLN12-08NC-E2	
			M18*82	16mm	TLN18-16NO-E2	TLN18-16NC-E2	
			M30*81	25mm	TLN30-25NO-E2	TLN30-25NC-E2	

Noted: Model numbers ended with "PO"/"PO-E1"/"PO-E2" are PNP normally open ; model numbers ended with "PC"/"PC-E1"/"PC-E2" are PNP normally closed.

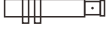
- Fiber Optic
- Slot Sensors
- Photoelectric
- Laser
- Proximity**
- Displacement
- Magnetic
- Contact
- Area
- Ultrasonic
- Vision
- Code Readers
- Vibration
- Temperature
- Accessories

- Guidance**
- Inductive sensors**
- Standard distance
- Extended distance
- Long distance
- Square
- Mini square
- Mini-cylindrical
- Short-body
- Ring-type
- Metal face
- Temperature
- IP69K high protection
- Analog output
- DC 2 wires
- Capacitive sensors**
- Cylindrical
- Correction resistanc type
- Flat type
- Level detection

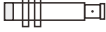
DC 3-wire **Long Distance**



Type	Appearance	Sensing distance	Model numbers		Pages	
			NPN Normally open	NPN Normally closed		
Unit: mm						
Pre-wired Type	Shielded	 $\phi 6.5 \times 45$	3mm	TYF6.5-03NO	TYF6.5-03NC	E-23
		 M8*45	3mm	TYF08-03NO	TYF08-03NC	
		 M12*45	6mm	TYF12-06NO	TYF12-06NC	
		 M18*54	12mm	TYF18-12NO	TYF18-12NC	
		 M30*54	22mm	TYF30-22NO	TYF30-22NC	
	Unshielded	 $\phi 6.5 \times 44$	6mm	TYN6.5-06NO	TYN6.5-06NC	
		 M8*44	6mm	TYN08-06NO	TYN08-06NC	
		 M12*53	10mm	TYN12-10NO	TYN12-10NC	
		 M18*58	20mm	TYN18-20NO	TYN18-20NC	
		 M30*61	40mm	TYN30-40NO	TYN30-40NC	
Connector Type	Shielded	 M8*60	3mm	TYF08-03NO-E1	TYF08-03NC-E1	
		 M12*68	6mm	TYF12-06NO-E2	TYF12-06NC-E2	
		 M18*82	12mm	TYF18-12NO-E2	TYF18-12NC-E2	
		 M30*78	22mm	TYF30-22NO-E2	TYF30-22NC-E2	
	Unshielded	 M8*60	6mm	TYN08-06NO-E1	TYN08-06NC-E1	
		 M12*71	10mm	TYN12-10NO-E2	TYN12-10NC-E2	
		 M18*82	20mm	TYN18-20NO-E2	TYN18-20NC-E2	
		 M30*81	40mm	TYN30-40NO-E2	TYN30-40NC-E2	

Noted: Model numbers ended with "PO"/"PO-E1"/"PO-E2" are PNP normally open ;model numbers ended with"PC"/"PC-E1"/"PC-E2" are PNP normally closed.

- Fiber Optic
- Slot Sensors
- Photoelectric
- Laser
- Proximity**
- Displacement
- Magnetic
- Contact
- Area
- Ultrasonic
- Vision
- Code Readers
- Vibration
- Temperature
- Accessories

Guidance









DC 3-wire **Square**

Type	Appearance	Sensing distance	Model numbers		Pages	
			NPN Normally open	NPN Normally closed		
Unit: mm						
Pre-wired Type	 Q17	Shielded	5mm	TQF17-05NO	TQF17-05NC	E-26
		Unshielded	8mm	TQN17-08NO	TQN17-08NC	
	 Q18	Shielded	5mm	TQF18-05NO HOT	TQF18-05NC	
		Unshielded	8mm	TQN18-08NO	TQN18-08NC	
	 Q18C	Shielded	5mm	TQF18C-05NO	TQF18C-05NC	
		Unshielded	8mm	TQN18C-08NO	TQN18C-08NC	

Noted: Model numbers ended with "PO" are PNP normally open ;model numbers ended with"PC" are PNP normally closed.



- Inductive sensors**
- Standard distance
- Extended distance
- Long distance
- Square
- Mini square
- Mini-cylindrical
- Short-body
- Ring-type
- Metal face
- Temperature
- IP69K high protection
- Analog output
- DC 2 wires
- Capacitive sensors**
- Cylindrical
- Correction resistanc type
- Flat type
- Level detection

Mini Square DC 3-wire

Type	Appearance	Sensing distance	Model numbers		Pages	
			NPN Normally open	NPN Normally closed		
Pre-wired Type	Unshielded	Unit: mm				
		 6.2*6.4*20.4	E06	1mm	TEN06-01NO	TEN06-01NC
		 6.1*6.3*20.4	E07	1mm	TEN07-01NO	TEN07-01NC
		 8*8.4*23.5	E08	2.5mm	TEN08-2.5NO HOT	TEN08-2.5NC
				3mm	TEN08-03NO	TEN08-03NC
		 8*8.4*25.5	E09	2.5mm	TEN09-2.5NO	TEN09-2.5NC
				3mm	TEN09-03NO HOT	TEN09-03NC
		 6.6*10.4*30.5	E10	2.5mm	TEN10-2.5NO	TEN10-2.5NC
4mm	TEN10-04NO			TEN10-04NC		
 8*12.4*30.5	E12	4mm	TEN12-04NO	TEN12-04NC		
 8*15.4*34.5	E15	5mm	TEN15-05NO	TEN15-05NC		
		8mm	TEN15-08NO	TEN15-08NC		
 15*16.4*34.5	E16	5mm	TEN16-05NO	TEN16-05NC		
		8mm	TEN16-08NO	TEN16-08NC		

Noted: Model numbers ended with "PO" are PNP normally open ;model numbers ended with "PC" are PNP normally closed.

Mini-cylindrical DC 3-wire





Type	Appearance	Sensing distance	Model numbers		Pages	
			NPN Normally open	NPN Normally closed		
Pre-wired Type	Shielded	Unit: mm				
			φ 3 * 25	0.6mm	TXF03-0.6NO	TXF03-0.6NC
				0.8mm	TXF03-0.8NO	TXF03-0.8NC
				1.0mm	TXF03-01NO	TXF03-01NC
			φ 4 * 25	0.8mm	TXF04-0.8NO	TXF04-0.8NC
				1.0mm	TXF04-01NO	TXF04-01NC
				1.2mm	TXF04-1.2NO	TXF04-1.2NC
			M4 * 25	1.5mm	TXF04-1.5NO	TXF04-1.5NC
				0.6mm	TXFM4-0.6NO	TXFM4-0.6NC
				0.8mm	TXFM4-0.8NO	TXFM4-0.8NC
			M5 * 25	1.0mm	TXFM4-01NO	TXFM4-01NC
				0.8mm	TXF05-0.8NO	TXF05-0.8NC
				1.0mm	TXF05-01NO	TXF05-01NC
			M5 * 25	1.2mm	TXF05-1.2NO	TXF05-1.2NC
				1.5mm	TXF05-1.5NO	TXF05-1.5NC

Noted: Model numbers ended with "PO" are PNP normally open ;model numbers ended with "PC" are PNP normally closed.

- Fiber Optic
- Slot Sensors
- Photoelectric
- Laser
- Proximity**
- Displacement
- Magnetic
- Contact
- Area
- Ultrasonic
- Vision
- Code Readers
- Vibration
- Temperature
- Accessories

- Inductive sensors**
- Standard distance
- Extended distance
- Long distance
- Square
- Mini square
- Mini-cylindrical
- Short-body
- Ring-type
- Metal face
- Temperature
- IP69K high protection
- Analog output
- DC 2 wires
- Capacitive sensors**
- Cylindrical
- Correction resistanc type
- Flat type
- Level detection

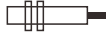
DC 3-wire **Ultra-short Body**

Type	Appearance	Sensing distance		Model numbers		Pages
		Unit: mm		NPN Normally open	NPN Normally closed	
Pre-wired Type	Shielded	 $\phi 6.5 \times 18$	1mm	TSSF6.5-01NO	TSSF6.5-01NC	E-31
			2mm	TSSF6.5-02NO	TSSF6.5-02NC	
			3mm	TSSF6.5-03NO	TSSF6.5-03NC	
		 $\phi 6.5 \times 18$	1mm	TSSF6.5Y-01NO	TSSF6.5Y-01NC	
			2mm	TSSF6.5Y-02NO	TSSF6.5Y-02NC	
			3mm	TSSF6.5Y-03NO	TSSF6.5Y-03NC	
	 M8*18	1mm	TSSF08-01NO	TSSF08-01NC		
		2mm	TSSF08-02NO HOT	TSSF08-02NC		
		 M12*22	2mm	TSSF12-02NO	TSSF12-02NC	
	4mm		TSSF12-04NO	TSSF12-04NC		

Noted: Model numbers ended with "PO" are PNP normally open ;model numbers ended with "PC" are PNP normally closed.

- Fiber Optic
- Slot Sensors
- Photoelectric
- Laser
- Proximity**
- Displacement
- Magnetic
- Contact
- Area
- Ultrasonic
- Vision
- Code Readers
- Vibration
- Temperature
- Accessories

DC 3-wire **Short-body**

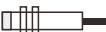
Type	Appearance	Sensing distance		Model numbers		Pages	
		Unit: mm		NPN Normally open	NPN Normally closed		
Pre-wired Type	Shielded		M8*35	1mm	TSF08-01NO	TSF08-01NC	E-32
				2mm	TSF08-02NO	TSF08-02NC	
			M12*35	2mm	TSF12-02NO	TSF12-02NC	
				4mm	TSF12-04NO	TSF12-04NC	
			M18*35	5mm	TSF18-05NO	TSF18-05NC	
				8mm	TSF18-08NO	TSF18-08NC	
			M30*35	10mm	TSF30-10NO	TSF30-10NC	
				16mm	TSF30-16NO	TSF30-16NC	
			Unshielded		M8*35	2mm	
	4mm	TSN08-04NO				TSN08-04NC	
	M12*35	4mm			TSN12-04NO	TSN12-04NC	
		8mm			TSN12-08NO	TSN12-08NC	
	M18*43	8mm			TSN18-08NO	TSN18-08NC	
		16mm			TSN18-16NO	TSN18-16NC	
	M30*47	15mm			TSN30-15NO	TSN30-15NC	
		25mm			TSN30-25NO	TSN30-25NC	

Noted: Model numbers ended with "PO" are PNP normally open ;model numbers ended with "PC" are PNP normally closed.

Guidance

- Inductive sensors**
- Standard distance
- Extended distance
- Long distance
- Square
- Mini square
- Mini-cylindrical
- Short-body
- Ring-type
- Metal face
- Temperature
- IP69K high protection
- Analog output
- DC 2 wires
- Capacitive sensors**
- Cylindrical
- Correction resistanc type
- Flat type
- Level detection

Ring-type DC 3-wire

Type	Appearance	Sensing distance		Model numbers		Pages	
		Unit: mm		NPN Normally open	NPN Normally closed		
Pre-wired Type		H10	Hole height:20	10.5mm	TH10-20NO	TH10-20NC	E-34
		H15	Hole height:20	15.5mm	TH15-20NO	TH15-20NC	
		H21	Hole height:20	22.5mm	TH21-20NO	TH21-20NC	
		H43	Hole height:20	43.5mm	TH43-20NO	TH43-20NC	

Noted: Model numbers ended with "PO" are PNP normally open ;model numbers ended with"PC" are PNP normally closed.



Metal Face DC 3-wire

Type	Appearance	Sensing distance		Model numbers		Pages	
		Unit: mm		NPN Normally open	NPN Normally closed		
Pre-wired Type	Shielded		M8*45	1mm	TMF08-01NO	TMF08-01NC	E-35
				2mm	TMF08-02NO	TMF08-02NC	
			M12*45	2mm	TMF12-02NO	TMF12-02NC	
				4mm	TMF12-04NO	TMF12-04NC	
			M18*54	5mm	TMF18-05NO	TMF18-05NC	
				8mm	TMF18-08NO	TMF18-08NC	
			M30*54	10mm	TMF30-10NO	TMF30-10NC	
	16mm	TMF30-16NO		TMF30-16NC			
	Unshielded		M8*49	2mm	TMN08-02NO	TMN08-02NC	
				3mm	TMN08-03NO	TMN08-03NC	
			M12*54	4mm	TMN12-04NO	TMN12-04NC	
				8mm	TMN12-08NO	TMN12-08NC	
			M18*62	8mm	TMN18-08NO	TMN18-08NC	
				16mm	TMN18-16NO	TMN18-16NC	
M30*66			15mm	TMN30-15NO	TMN30-15NC		
	25mm	TMN30-25NO	TMN30-25NC				

Noted: Model numbers ended with "PO" are PNP normally open ;model numbers ended with"PC" are PNP normally closed.



- Fiber Optic
- Slot Sensors
- Photoelectric
- Laser
- Proximity**
- Displacement
- Magnetic
- Contact
- Area
- Ultrasonic
- Vision
- Code Readers
- Vibration
- Temperature
- Accessories
- Guidance**
- Inductive sensors**
- Standard distance
- Extended distance
- Long distance
- Square
- Mini square
- Mini-cylindrical
- Short-body
- Ring-type
- Metal face
- Temperature
- IP69K high protection
- Analog output
- DC 2 wires
- Capacitive sensors**
- Cylindrical
- Correction resistanc type
- Flat type
- Level detection

DC 3-wire **Temperature Resistance**

	Type	Appearance	Sensing distance		Model numbers		Pages
			Unit: mm		NPN Normally open	NPN Normally closed	
High temperature resistant	Shielded		M12*54	2mm	TGF12-02NO	TGF12-02NC	E-37
			M18*55	5mm	TGF18-05NO	TGF18-05NC	
			M30*51.5	10mm	TGF30-10NO	TGF30-10NC	
	Unshielded		M12*51	4mm	TGN12-04NO	TGN12-04NC	
			M18*51.5	8mm	TGN18-08NO HOT	TGN18-08NC	
			M30*51.5	15mm	TGN30-15NO	TGN30-15NC	
	Shielded		M12*55	2mm	TGF12-02NO2	TGF12-02PO2	
			M18*55	5mm	TGF18-05NO2	TGF18-05PO2	
			M30*54	10mm	TGF30-10NO2	TGF30-10PO2	

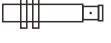

Noted: Model numbers ended with "PO" are PNP normally open ; model numbers ended with "PC" are PNP normally closed.

IP69K High Protection

	Type	Appearance	Sensing distance		Model numbers		Pages
			Unit: mm		NPN	PNP	
Pre-wired Type	Shielded		M12*64.6	2mm	TPF12-02NR-E2	TPF12-02PR-E2	E-39
				4mm	TPF12-04NR-E2	TPF12-04PR-E2	
			M18*63.1	5mm	TPF18-05NR-E2	TPF18-05PR-E2	E-40
				8mm	TPF18-08NR-E2	TPF18-08PR-E2	
	Unshielded		M12*64.6	4mm	TPN12-04NR-E2	TPN12-04PR-E2	E-39
				8mm	TPN12-08NR-E2	TPN12-08PR-E2	
			M18*63.1	8mm	TPN18-08NR-E2	TPN18-08PR-E2	E-40
				12mm	TPN18-12NR-E2	TPN18-12PR-E2	

Note: The model ending with **NR-E2 is NPN normally open + normally closed; the model ending with **PR-E2 is PNP normally open + normally closed.

DC 3-wire **Analog Output**





	Type	Appearance	Sensing distance		Model numbers		Pages
			Unit: mm		PNP Current output	PNP Voltage output	
Pre-wired Type	Shielded		M12*45	3mm	TAF12-03PA	TAF12-03PV	E-41
			M18*54	4mm	TAF18-04PA	TAF18-04PV	
			M30*54	10mm	TAF30-10PA	TAF30-10PV	
	Unshielded		M12*44	4mm	TAN12-04PA	TAN12-04PV	
			M18*54	7mm	TAN18-07PA	TAN18-07PV	
			M30*58	14mm	TAN30-14PA	TAN30-14PV	

- Fiber Optic
- Slot Sensors
- Photoelectric
- Laser
- Proximity**
- Displacement
- Magnetic
- Contact
- Area
- Ultrasonic
- Vision
- Code Readers
- Vibration
- Temperature
- Accessories

Guidance

- Inductive sensors**
- Standard distance
- Extended distance
- Long distance
- Square
- Mini square
- Mini-cylindrical
- Short-body
- Ring-type
- Metal face
- Temperature
- IP69K high protection
- Analog output
- DC 2 wires
- Capacitive sensors**
- Cylindrical
- Correction resistanc type
- Flat type
- Level detection

DC 2-Wire

Type	Appearance	Sensing distance		Model numbers		Pages
		Unit: mm		Normally open	Normally closed	
Pre-wired Type	Shielded		φ 6.5*45	1mm	TDF6.5-01HO	TDF6.5-01HC
				2mm	TDF6.5-02HO	TDF6.5-02HC
			M8*45	1mm	TDF08-01HO	TDF08-01HC
		2mm		TDF08-02HO	TDF08-02HC	
		M12*45	2mm	TDF12-02HO	TDF12-02HC	
			4mm	TDF12-04HO	TDF12-04HC	
			M18*54	5mm	TDF18-05HO	TDF18-05HC
				8mm	TDF18-08HO	TDF18-08HC
			M30*54	10mm	TDF30-10HO	TDF30-10HC
			16mm	TDF30-16HO	TDF30-16HC	
	Unshielded		φ 6.5*44	2mm	TDN6.5-02HO	TDN6.5-02HC
				4mm	TDN6.5-04HO	TDN6.5-04HC
			M8*44	2mm	TDN08-02HO	TDN08-02HC
				4mm	TDN08-04HO	TDN08-04HC
			M12*44	4mm	TDN12-04HO	TDN12-04HC
				8mm	TDN12-08HO	TDN12-08HC
			M18*54	8mm	TDN18-08HO	TDN18-08HC
				16mm	TDN18-16HO	TDN18-16HC
M30*58			15mm	TDN30-15HO	TDN30-15HC	
		25mm	TDN30-25HO	TDN30-25HC		

F-42

Guidance



Inductive sensors

- Standard distance
- Extended distance
- Long distance
- Square
- Mini square
- Mini-cylindrical
- Short-body
- Ring-type
- Metal face
- Temperature
- IP69K high protection
- Analog output
- DC 2 wires

Capacitive sensors

- Cylindrical
- Correction resistanc type
- Flat type
- Level detection

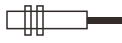
DC 3-wire **Cylindrical**



Type	Appearance	Sensing distance	Model numbers		Pages		
			NPN Normally open	NPN Normally closed			
Plastic Shells	Shielded		M12*55	3mm	CKF12-03NO	CKF12-03NC	E-44
		M18*70	8mm	CKF18-08NO	CKF18-08NC		
		M30*80	20mm	CKF30-20NO	CKF30-20NC		
	Unshielded		M12*59	6mm	CKN12-06NO	CKN12-06NC	
		M18*73	15mm	CKN18-15NO	CKN18-15NC		
		M30*82	30mm	CKN30-30NO	CKN30-30NC		

Noted: Model numbers ended with "PO" are PNP normally open ; model numbers ended with "PC" are PNP normally closed.

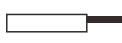

DC 4-wire **Corrosion Resistant Type**

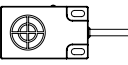
Type	Appearance	Sensing distance	Model numbers	Pages	
Teflon casing Shielded		M18*70.5	10mm	CWF18-10NP	E-45

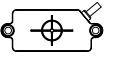
DC 3-wire **Flat Type**

Appearance	Sensing distance	Model numbers	Pages
	5mm	CQ07-05NO/NC/PO/PC	E-46
	10mm	CQ07-10NO/NC/PO/PC	
	8mm	CQ07-08NO/NC/PO/PC	E-47

DC 3-wire **Liquid Level Detection**

Type	Appearance	Exterior diameter of pipes	Model numbers	Pages	
Unshielded		φ 8~ φ 11	CE15-13NO	CE15-13NC	E-48
		φ 12~ φ 26	CE30-26NO 	CE30-26NC	

Noted: Model numbers ended with "PO" are PNP normally open ; model numbers ended with "PC" are PNP normally closed.

- Fiber Optic
- Slot Sensors
- Photoelectric
- Laser
- Proximity**
- Displacement
- Magnetic
- Contact
- Area
- Ultrasonic
- Vision
- Code Readers
- Vibration
- Temperature
- Accessories

Guidance

- Inductive sensors**
- Standard distance
- Extended distance
- Long distance
- Square
- Mini square
- Mini-cylindrical
- Short-body
- Ring-type
- Metal face
- Temperature
- IP69K high protection
- Analog output
- DC 2 wires

Capacitive sensors

- Cylindrical
- Correction resistanc type
- Flat type
- Level detection

Input/Output Circuit

DC 4-Wire

NPN Output

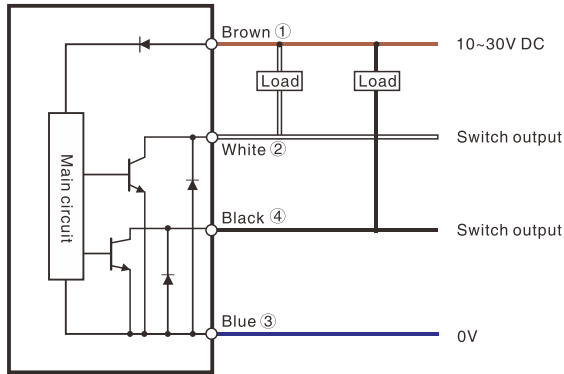

PNP Output

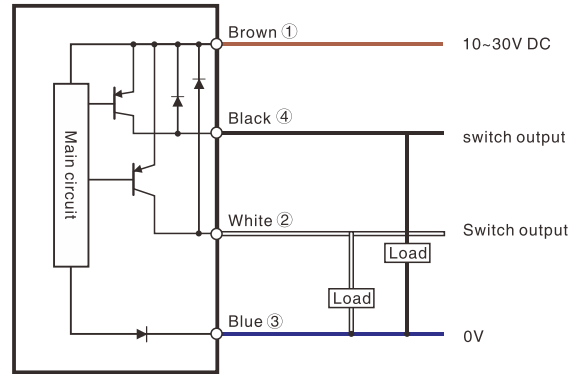

DC 3-Wire

NPN Output

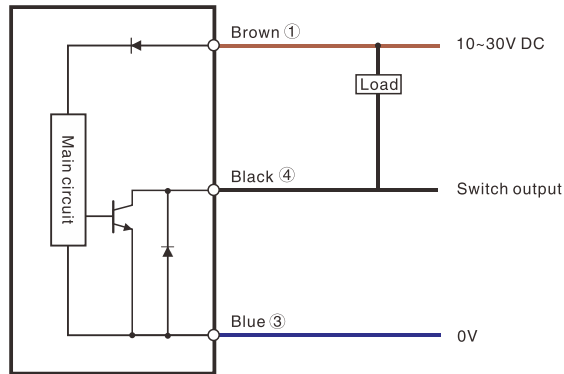

PNP Output

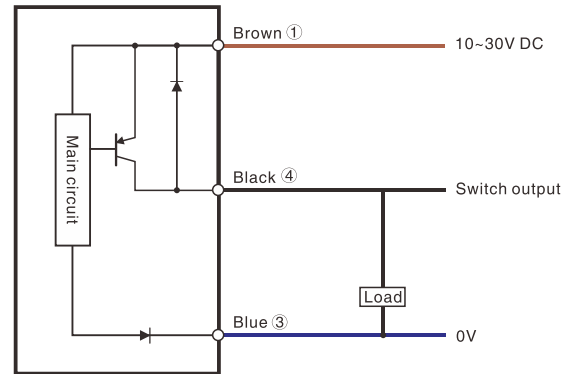

DC 2-Wire

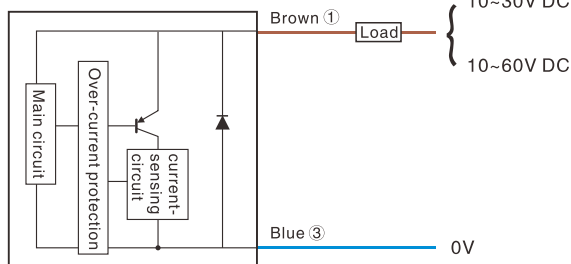

*Load (can be connected between blue wire and negative power supply.)
M8 sensor does not include short-circuit protection or current detection circuit. 1 and 4 in the circuit diagram show the connection of the connector type.

Analog

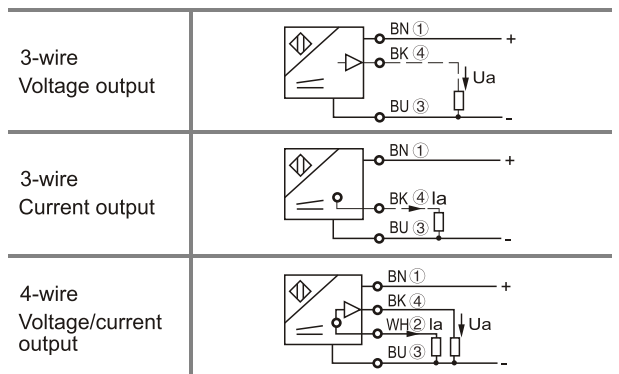

Configuration of Connector Type Sensor

Note: Terminal 1 and 4 are used in connector models

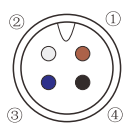

M12 4 pin

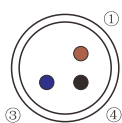

M8 3 pin

- Fiber Optic
- Slot Sensors
- Photoelectric
- Laser
- Proximity**
- Displacement
- Magnetic
- Contact
- Area
- Ultrasonic
- Vision
- Code Readers
- Vibration
- Temperature
- Accessories

Guidance

- Inductive sensors**
- Standard distance
- Extended distance
- Long distance
- Square
- Mini square
- Mini-cylindrical
- Short-body
- Ring-type
- Metal face
- Temperature
- IP69K high protection
- Analog output
- DC 2 wires

- Capacitive sensors**
- Cylindrical
- Correction resistanc type
- Flat type
- Level detection

Inductance Attenuation Coefficient

Sensing distance=Nominal sensing distance*Attenuation factor

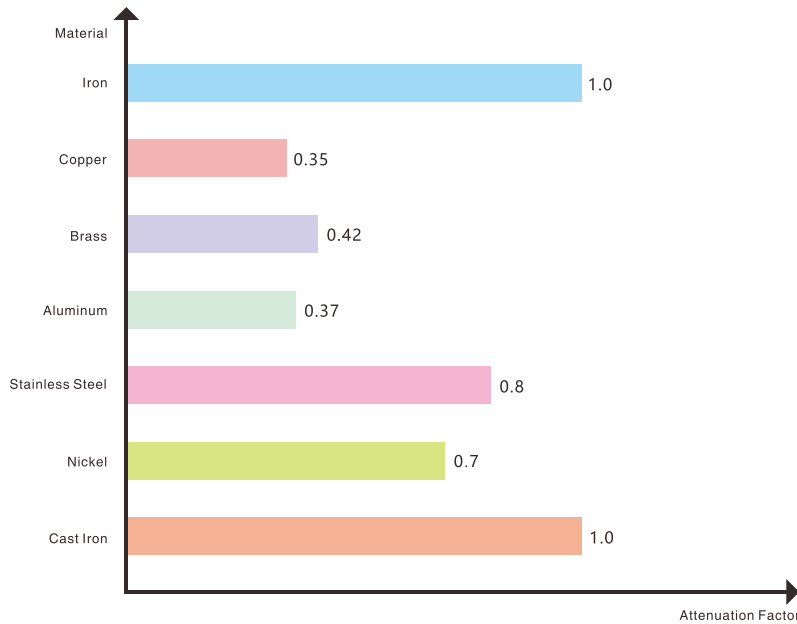

Note:
 1. Proper installation: shielded or unshielded
 2. Specifications
 3. Sensing distance
 4. Feature of detecting objects(material and size)

Capacitive Sensors Dielectric Constant

For capacitive sensors, the sensing distance and sensitivity vary due to changes in the dielectric constant of the target object. The bigger the dielectric constant of the target object, the farther the sensing distance of the sensor

Dielectric Constant chart

Material	Dielectric Constant
Air	1
Wood	2~7
Paper	2.3
Polypropylene	2.3
Rubber, neoprene	2.5
Porcelain	4.4
Glass, pyrex	5
Water	80

- Fiber Optic
- Slot Sensors
- Photoelectric
- Laser
- Proximity**
- Displacement
- Magnetic
- Contact
- Area
- Ultrasonic
- Vision
- Code Readers
- Vibration
- Temperature
- Accessories

Guidance

- Inductive sensors**
- Standard distance
- Extended distance
- Long distance
- Square
- Mini square
- Mini-cylindrical
- Short-body
- Ring-type
- Metal face
- Temperature
- IP69K high protection
- Analog output
- DC 2 wires

- Capacitive sensors**
- Cylindrical
- Correction resistanc type
- Flat type
- Level detection

Mounting Method-Shielded, Unshielded

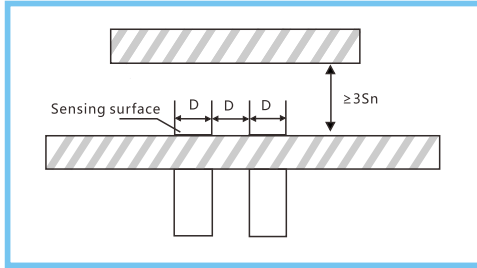

Shielded Mounting Proximity Sensors

Sensing surface must be flush with metal surface

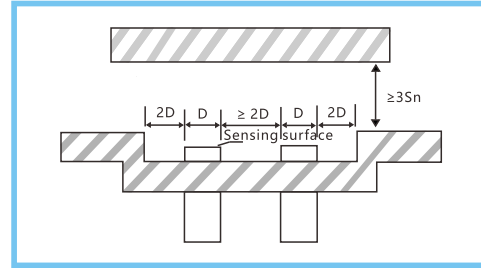

Unshielded Mounting Proximity Sensors

The distance between sensing surface to surrounding metals must be more than 2 times sensing distance

Mounting Torque

Cylindrical Type

1. $\phi 3/3.4/4$: Fix the sensing head with a screw at 7mm where it is near the tip part;
2. $\phi 6.5$ Shielded mounting: Fix the sensing head with a screw at 8mm where it is near the tip part;
3. $\phi 6.5$ Unshielded mounting: Fix the sensing head with a screw at 12mm where it is near the tip part.

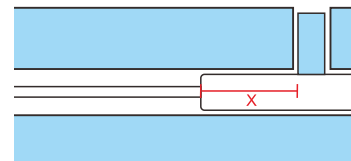

$\phi 3/ \phi 3.4/ \phi 4$: X=7mm $\phi 6.5$: X=8-12mm

Thread Type

When installing a threaded sensor, please do not exceed the torque listed below.

Model No.	Tightening torque N
M4*0.5	1.5
M5*0.5	1.5
M8*1	3.5
M12*1	16
M18*1	28
M30*1.5	150

- Fiber Optic
- Slot Sensors
- Photoelectric
- Laser
- Proximity**
- Displacement
- Magnetic
- Contact
- Area
- Ultrasonic
- Vision
- Code Readers
- Vibration
- Temperature
- Accessories

Guidance

Inductive sensors

Standard distance

Extended distance

Long distance

Square

Mini square

Mini-cylindrical

Short-body

Ring-type

Metal face

Temperature

IP69K high protection

Analog output

DC 2 wires

Capacitive sensors

Cylindrical

Correction

resistance type

Flat type

Level detection

Capacitive Sensors



No.	Classification	Explanation of model numbers
①	Series	A: Analog Output D: DC 2-wire E: Mini Square G: High-temperature Resistant H: Ring-type L: Extended Distance M: Metal Face Q: Square R: Standard Distance S: Short-body P: IP69K SS: Extra Short Outer Casing X: Mini-cylindrical Y: Long Distance Z: Low Temperature Resistant
②	Mounting	F: Shielded N: Unshielded
③	Specifications	08: M8 12: M12 18: M18 30: M30
④	Sensing Distance	1.5: 1.5mm 02: 2mm 05: 5mm 08: 8mm
⑤	Output Type	N: NPN P: PNP H: DC 2-Wire
⑥	Output Status	O: Normally open C: Normally closed A: Current output V: Voltage output
⑦	Connection	Null: Pre-wired type E1: M8 3 pin connector E2: M12 4 pin connector

- Fiber Optic
- Slot Sensors
- Photoelectric
- Laser
- Proximity**
- Displacement
- Magnetic
- Contact
- Area
- Ultrasonic
- Vision
- Code Readers
- Vibration
- Temperature
- Accessories

Guidance

- Inductive sensors**
- Standard distance
- Extended distance
- Long distance
- Square
- Mini square
- Mini-cylindrical
- Short-body
- Ring-type
- Metal face
- Temperature
- IP69K high protection
- Analog output
- DC 2 wires

- Capacitive sensors**
- Cylindrical
- Correction resistanc type
- Flat type
- Level detection

Capacitive Sensors



No.	Classification	Explanation of model numbers
①	Series	E: Liquid Level Detection K: Plastic Shells Q: Flat Type W: Corrosion resistant
②	Mounting	F: Shielded N: Unshielded
③	Specifications	08: M8 12: M12 18: M18 30: M30
④	Sensing Distance	1.5: 1.5mm 02: 2mm 05: 5mm 08: 8mm
⑤	Output Type	N: NPN P: PNP H: DC 2-Wire
⑥	Output Status	O: Normally open C: Normally closed
⑦	Connection	Null: Pre-wired type E1: M8 3 pin connector E2: M12 4 pin connector

Standard Distance

Pre-wired



Appearance	Shielded		Shielded			Unshielded		Unshielded			
Mounting	Shielded		Shielded			Unshielded		Unshielded			
Size	φ 6.5	M8	M12	M18	M30	φ 6.5	M8	M12	M18	M30	
Sensing distance	1.5mm ± 10%	1.5mm ± 10%	2mm ± 10%	5mm ± 10%	10mm ± 10%	2mm ± 10%	2mm ± 10%	4mm ± 10%	8mm ± 10%	15mm ± 10%	
Housing material	Stainless steel		Nickel copper alloy			Stainless steel		Nickel copper alloy			
Operating voltage	10~30V DC(Ripple < 10%)										
Voltage drop	< 1.5V		< 2.0V			< 1.5V		< 2.0V			
Load Current, Max	150mA										
Current consumption	< 10mA					< 20mA					
Leakage current	< 0.01mA										
Switch frequency	2KHz	1.5KHz	1KHz	300Hz	2KHz	1KHz	800Hz	500Hz	150Hz		
Repeat accuracy	< 1.0% (Sr)							< 5.0% (Sr)		< 1.0% (Sr)	
Hysteresis	< 15% (Sr)										
Sensing surface material	PBT										
Operating temperature	-25°C~+75°C										
Circuit Protection	Short circuit										
Degree of protection	IP67										
Model No.	NPN Normally open	TRF6.5-1.5[N]O	TRF08-1.5[N]O	TRF12-02[N]O	TRF18-05[N]O	TRF30-10[N]O	TRN6.5-02[N]O	TRN08-02[N]O	TRN12-04[N]O	TRN18-08[N]O	TRN30-15[N]O
	Others	[N]O: NPN Normally open		[N]C: NPN Normally closed		[P]O: PNP Normally open		[P]C: PNP Normally closed			

Connector Type



Appearance	Shielded				Unshielded				
Mounting	Shielded				Unshielded				
Size	M8	M12	M18	M30	M8	M12	M18	M30	
Sensing distance	1.5mm ± 10%	2mm ± 10%	5mm ± 10%	10mm ± 10%	2mm ± 10%	4mm ± 10%	8mm ± 10%	15mm ± 10%	
Housing material	Stainless steel	Nickel copper alloy			Stainless steel	Nickel copper alloy			
Operating voltage	10~30V DC(Ripple < 10%)								
Voltage drop	< 1.5V								
Load Current Max	150mA								
Current consumption	< 10mA								
Leakage current	< 0.01mA								
Switch frequency	1.5KHz	2KHz	1KHz	300Hz	1KHz	500Hz	150Hz		
Repeat accuracy	< 1.0% (Sr)								
Hysteresis	< 15% (Sr)								
Sensing surface material	PBT								
Operating temperature	-25°C~+75°C								
Circuit Protection	Short circuit								
Degree of protection	IP67								
Model No.	NPN Normally open	TRF08-1.5[N]O-E1	TRF12-02[N]O-E2	TRF18-05[N]O-E2	TRF30-10[N]O-E2	TRN08-02[N]O-E1	TRN12-04[N]O-E2	TRN18-08[N]O-E2	TRN30-15[N]O-E2
	Others	[N]O: NPN Normally open		[N]C: NPN Normally closed		[P]O: PNP Normally open		[P]C: PNP Normally closed	

φ6.5

TRF6.5-1.5□□

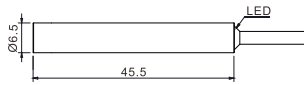

TRN6.5-02□□

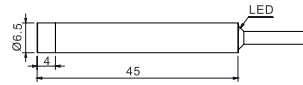

M8

TRF08-1.5□□

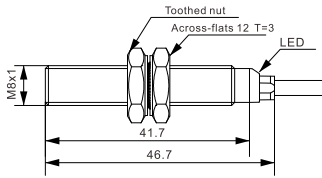

TRN08-02□□

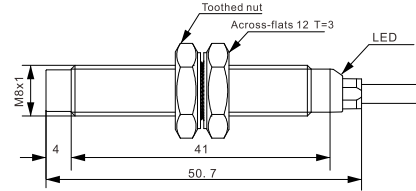

M12

TRF12-02□□

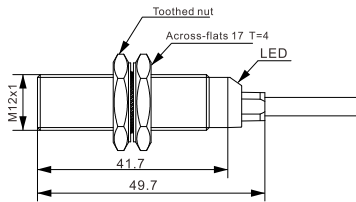

TRN12-04□□

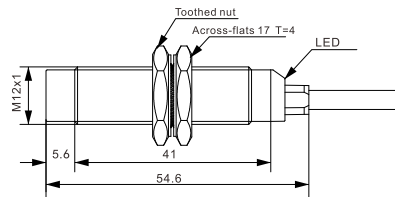

M18

TRF18-05□□

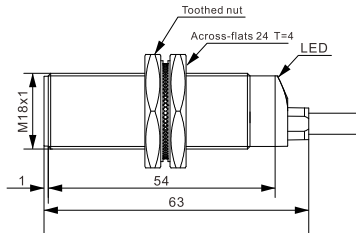

TRN18-08□□

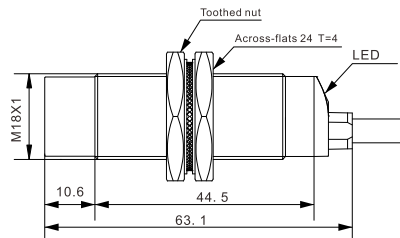

M30

TRF30-10□□

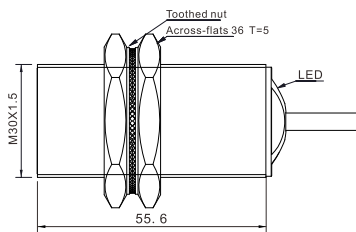

TRN30-15□□

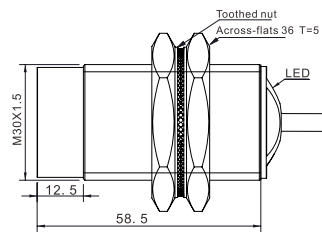

- Fiber Optic
- Slot Sensors
- Photoelectric
- Laser
- Proximity**
- Displacement
- Magnetic
- Contact
- Area
- Ultrasonic
- Vision
- Code Readers
- Vibration
- Temperature
- Accessories

Guidance

- Inductive sensors
- Standard distance**
- Extended distance
- Long distance
- Square
- Mini square
- Mini-cylindrical
- Short-body
- Ring-type
- Metal face
- Temperature
- IP69K high protection
- Analog output
- DC 2 wires

Capacitive sensors

- Cylindrical
- Correction resistanc type
- Flat type
- Level detection

Standard Distance

Dimensions- Connector Type (Unit:mm)

M8

TRF08-1.5□□-E1

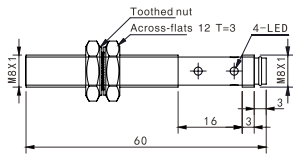

TRN08-02□□-E1

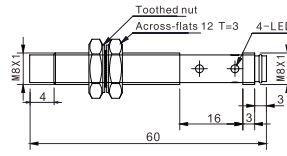

M12

TRF12-02□□-E2

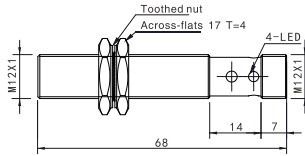

TRN12-04□□-E2

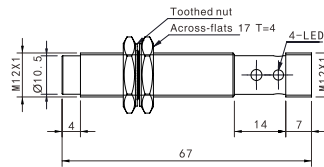

M18

TRF18-05□□-E2

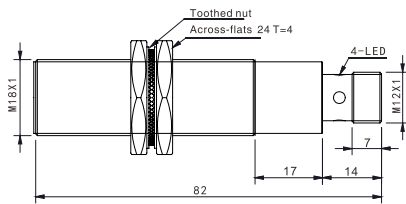

TRN18-08□□-E2

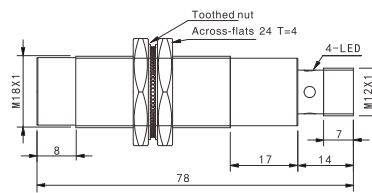

M30

TRF30-10□□-E2

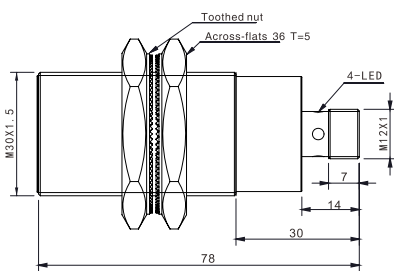

TRN30-15□□-E2

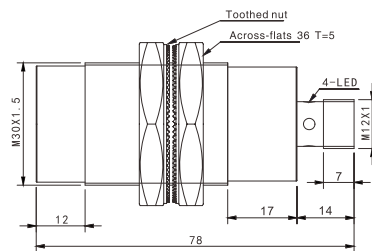

- Fiber Optic
- Slot Sensors
- Photoelectric
- Laser
- Proximity**
- Displacement
- Magnetic
- Contact
- Area
- Ultrasonic
- Vision
- Code Readers
- Vibration
- Temperature
- Accessories

Guidance

- Inductive sensors
- Standard distance**
- Extended distance
- Long distance
- Square
- Mini square
- Mini-cylindrical
- Short-body
- Ring-type
- Metal face
- Temperature
- IP69K high protection
- Analog output
- DC 2 wires

Capacitive sensors

- Cylindrical
- Correction
- resistance type
- Flat type
- Level detection



Appearance											
Mounting	Shielded		Shielded			Unshielded		Unshielded			
Size	φ 6.5	M8	M12	M18	M30	φ 6.5	M8	M12	M18	M30	
Sensing distance	2mm ± 10%	2mm ± 10%	4mm ± 10%	8mm ± 10%	16mm ± 10%	4mm ± 10%	4mm ± 10%	8mm ± 10%	16mm ± 10%	25mm ± 10%	
Housing material	Stainless steel		Nickel copper alloy			Stainless steel		Nickel copper alloy			
Operating voltage	10~30V DC(Ripple < 10%)										
Voltage drop	< 1.5V		< 2.0V			< 1.5V		< 2.0V			
Load Current, Max	150mA										
Current consumption	< 10mA										
Leakage current	< 0.01mA										
Switch frequency	2KHz	1KHz	300Hz	500Hz	150Hz	1KHz	800Hz	500Hz	150Hz	100Hz	
Repeat accuracy	< 1.0%(Sr)		< 5.0%(Sr)			< 1.0%(Sr)		< 5.0%(Sr)		< 1.0%(Sr)	
Hysteresis	< 15%(Sr)										
Sensing surface material	PBT										
Operating temperature	-25°C~+75°C										
Circuit Protection	Short circuit										
Degree of protection	IP67										
Model No.	NPN Normally open	TLF6.5-02	TLF08-02	TLF12-04	TLF18-08	TLF30-16	TLN6.5-04	TLN08-04	TLN12-08	TLN18-16	TLN30-25
	Others	NO :NPN Normally open NC :NPN Normally closed PO :PNP Normally open PC :PNP Normally closed									

- Fiber Optic
- Slot Sensors
- Photoelectric
- Laser
- Proximity**
- Displacement
- Magnetic
- Contact
- Area
- Ultrasonic
- Vision
- Code Readers
- Vibration
- Temperature
- Accessories

Connector Type



Appearance									
Mounting	Shielded				Unshielded				
Size	M8	M12	M18	M30	M8	M12	M18	M30	
Sensing distance	2mm ± 10%	4mm ± 10%	8mm ± 10%	16mm ± 10%	4mm ± 10%	8mm ± 10%	16mm ± 10%	25mm ± 10%	
Housing material	Stainless steel	Nickel copper alloy			Stainless steel	Nickel copper alloy			
Operating voltage	10~30V DC(Ripple < 10%)								
Voltage drop	< 1.5V								
Load Current, Max	150mA								
Current consumption	< 10mA								
Leakage current	< 0.01mA								
Switch frequency	1KHz		500Hz	150Hz	800Hz	500Hz	150Hz	100Hz	
Repeat accuracy	< 1.0%(Sr)								
Hysteresis	< 15%(Sr)								
Sensing surface material	PBT								
Operating temperature	-25°C~+75°C								
Circuit Protection	Short circuit								
Degree of protection	IP67								
Model No.	NPN Normally open	TLF08-02	TLF12-04	TLF18-08	TLF30-16	TLN08-04	TLN12-08	TLN18-16	TLN30-25
	Others	NO :NPN Normally open NC :NPN Normally closed PO :PNP Normally open PC :PNP Normally closed							

Guidance

- Inductive sensors
- Standard distance
- Extended distance**
- Long distance
- Square
- Mini square
- Mini-cylindrical
- Short-body
- Ring-type
- Metal face
- Temperature
- IP69K high protection
- Analog output
- DC 2 wires
- Capacitive sensors
- Cylindrical
- Correction resistanc type
- Flat type
- Level detection

Extended Distance

Dimensions-Pre-wired Type (Unit:mm)

φ6.5

TLF6.5-02□□

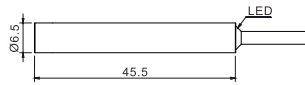

TLN6.5-04□□

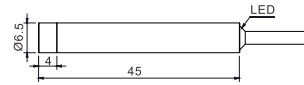

M8

TLF08-02□□

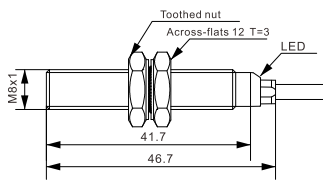

TLN08-04□□

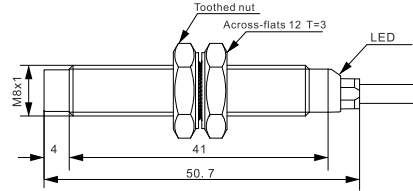

M12

TLF12-04□□

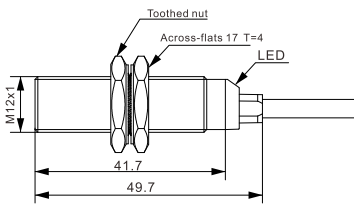

TLN12-08□□

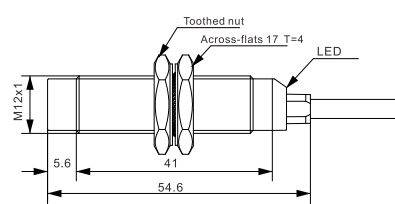

M18

TLF18-08□□

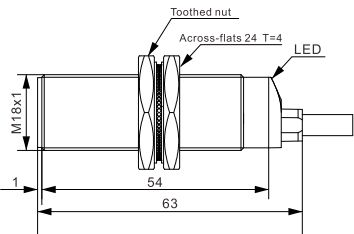

TLN18-16□□

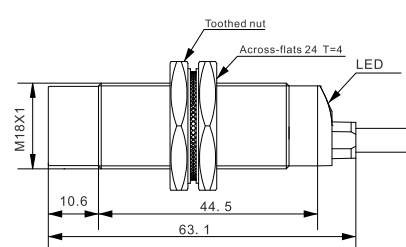

M30

TLF30-16□□

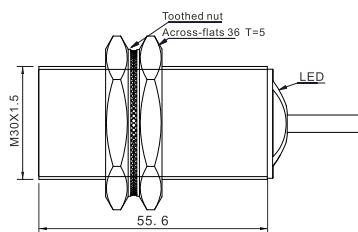

TLN30-25□□

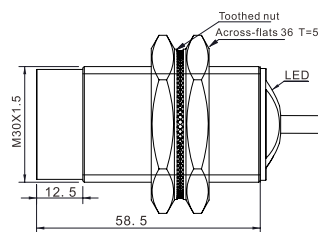

- Fiber Optic
- Slot Sensors
- Photoelectric
- Laser
- Proximity**
- Displacement
- Magnetic
- Contact
- Area
- Ultrasonic
- Vision
- Code Readers
- Vibration
- Temperature
- Accessories

Guidance

- Inductive sensors
- Standard distance
- Extended distance**
- Long distance
- Square
- Mini square
- Mini-cylindrical
- Short-body
- Ring-type
- Metal face
- Temperature
- IP69K high protection
- Analog output
- DC 2 wires

- Capacitive sensors
- Cylindrical
- Correction resistanc type
- Flat type
- Level detection

M8

TLF08-02□□-E1

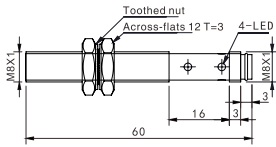

TLN08-04□□-E1

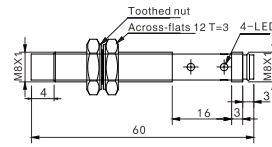

M8 3PIN

M12

TLF12-04□□-E2

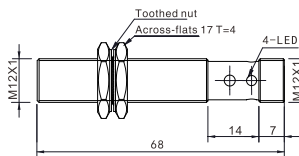

TLN12-08□□-E2

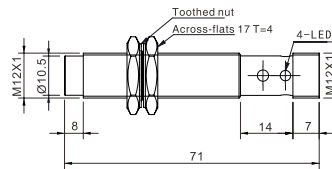

M12 4PIN

M18

TLF18-08□□-E2

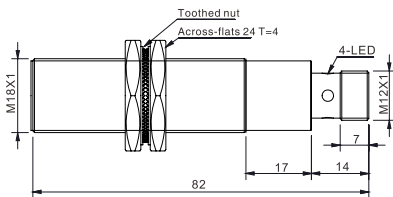

TLN18-16□□-E2

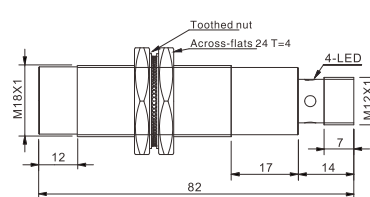

M12 4PIN

M30

TLF30-16□□-E2

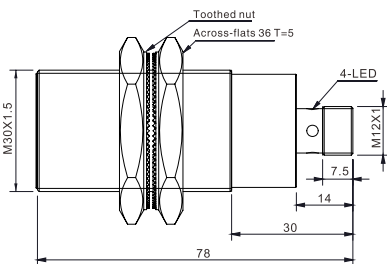

TLN30-25□□-E2

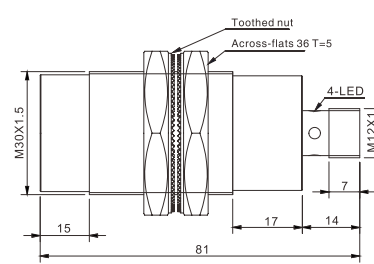

M12 4PIN

- Fiber Optic
- Slot Sensors
- Photoelectric
- Laser
- Proximity**
- Displacement
- Magnetic
- Contact
- Area
- Ultrasonic
- Vision
- Code Readers
- Vibration
- Temperature
- Accessories

Guidance

Inductive sensors

- Standard distance
- Extended distance**
- Long distance
- Square
- Mini square
- Mini-cylindrical
- Short-body
- Ring-type
- Metal face
- Temperature
- IP69K high protection
- Analog output
- DC 2 wires

Capacitive sensors

- Cylindrical
- Correction resistanc type
- Flat type
- Level detection

Long Distance

Pre-wired



Appearance											
Mounting	Shielded		Shielded			Unshielded		Unshielded			
Size	φ 6.5	M8	M12	M18	M30	φ 6.5	M8	M12	M18	M30	
Sensing distance	3mm ± 10%	3mm ± 10%	6mm ± 10%	12mm ± 10%	22mm ± 10%	6mm ± 10%	6mm ± 10%	10mm ± 10%	20mm ± 10%	40mm ± 10%	
Housing material	Stainless steel		Nickel copper alloy			Stainless steel		Nickel copper alloy			
Operating voltage	10~30V DC(Ripple < 10%)										
Voltage drop	< 1.5V										
Load Current, Max	150mA										
Current consumption	< 10mA										
Leakage current	< 0.01mA										
Switch frequency	1KHz		800Hz	300Hz	150Hz	500Hz		400Hz	100Hz		
Repeat accuracy	< 5.0% (Sr)										
Hysteresis	< 15% (Sr)										
Sensing surface material	PBT										
Operating Temperature	-25°C~+75°C										
Circuit Protection	Short circuit										
Degree of protection	IP67										
Model No.	NPN Normally open	TYF6.5-03	TYF08-03	TYF12-06	TYF18-12	TYF30-22	TYN6.5-06	TYN08-06	TYN12-10	TYN18-20	TYN30-40
	Others	NO :NPN Normally open NC :NPN Normally closed PO :PNP Normally open PC :PNP Normally closed									

Connector Type

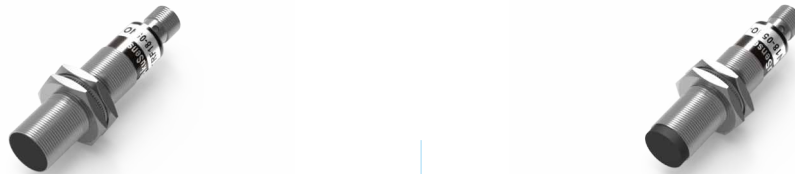

Appearance									
Mounting	Shielded				Unshielded				
Size	M8	M12	M18	M30	M8	M12	M18	M30	
Sensing distance	3mm ± 10%	6mm ± 10%	12mm ± 10%	22mm ± 10%	6mm ± 10%	10mm ± 10%	20mm ± 10%	40mm ± 10%	
Housing material	Stainless steel	Nickel copper alloy			Stainless steel	Nickel copper alloy			
Operating voltage	10~30V DC(Ripple < 10%)								
Voltage drop	< 1.5V								
Load Current , Max	150mA								
Current consumption	< 10mA								
Leakage current	< 0.01mA								
Switch frequency	1KHz	800Hz	300Hz	150Hz	500Hz	400Hz	100Hz		
Repeat accuracy	< 5.0% (Sr)								
Hysteresis	< 15% (Sr)								
Sensing surface material	PBT								
Operating Temperature	-25°C~+75°C								
Circuit Protection	Short circuit								
Degree of protection	IP67								
Model No.	NPN Normally open	TYF08-03	TYF12-06	TYF18-12	TYF30-22	TYN08-06	TYN12-10	TYN18-20	TYN30-40
	Others	NO :NPN Normally open NC :NPN Normally closed PO :PNP Normally open PC :PNP Normally closed							

φ6.5

TYF6.5-03□□

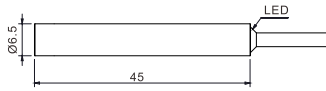

TYN6.5-06□□

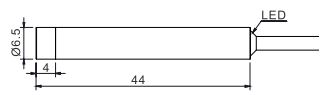

M8

TYF08-03□□

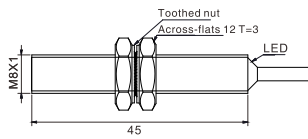

TYN08-06□□

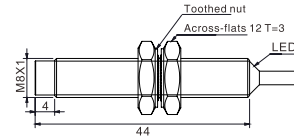

M12

TYF12-06□□

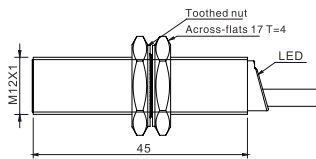

TYN12-10□□

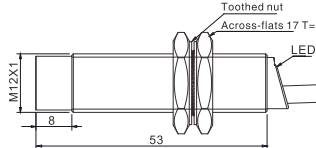

M18

TYF18-12□□

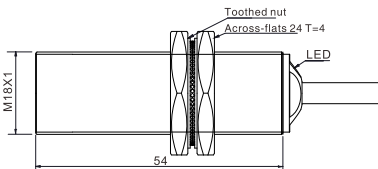

TYN18-20□□

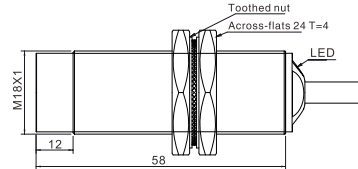

M30

TYF30-22□□

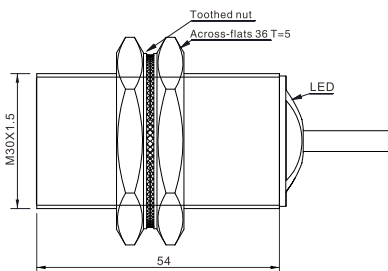

TYN30-40□□

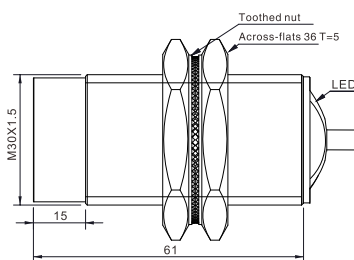

Fiber Optic
Slot Sensors
Photoelectric
Laser
Proximity
Displacement
Magnetic
Contact
Area
Ultrasonic
Vision
Code Readers
Vibration
Temperature
Accessories

Guidance

Inductive sensors
Standard distance
Extended distance
Long distance
Square
Mini square
Mini-cylindrical
Short-body
Ring-type
Metal face
Temperature
IP69K high protection
Analog output
DC 2 wires

Capacitive sensors
Cylindrical
Correction resistanc type
Flat type
Level detection

Long Distance

Dimensions-Connector Type (Unit:mm)

M8

TYF08-03□□-E1

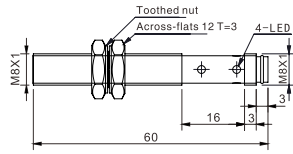

TYN08-06□□-E1

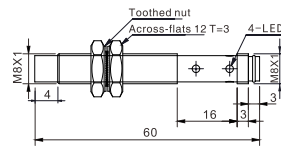

M12

TYF12-06□□-E2

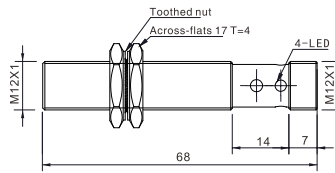

TYN12-10□□-E2

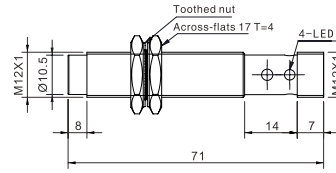

M18

TYF18-12□□-E2

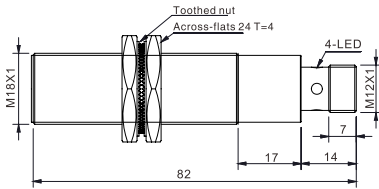

TYN18-20□□-E2

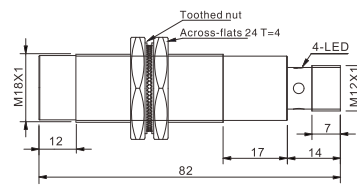

M30

TYF30-22□□-E2

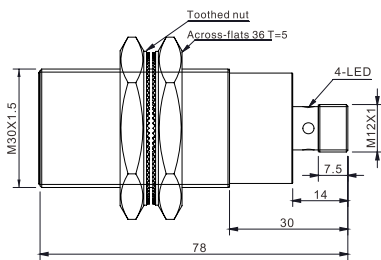

TYN30-40□□-E2

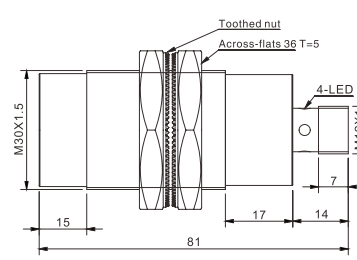

- Fiber Optic
- Slot Sensors
- Photoelectric
- Laser
- Proximity**
- Displacement
- Magnetic
- Contact
- Area
- Ultrasonic
- Vision
- Code Readers
- Vibration
- Temperature
- Accessories

Guidance

- Inductive sensors**
- Standard distance
- Extended distance
- Long distance**
- Square
- Mini square
- Mini-cylindrical
- Short-body
- Ring-type
- Metal face
- Temperature
- IP69K high protection
- Analog output
- DC 2 wires

Capacitive sensors

- Cylindrical
- Correction resistanc type
- Flat type
- Level detection



Mounting	Shielded	Unshielded	Shielded	Unshielded	Shielded	Unshielded
Size	Q17		Q18		Q18C	
Sensing distance	5mm ± 10%	8mm ± 10%	5mm ± 10%	8mm ± 10%	5mm ± 10%	8mm ± 10%
Housing material	Plastic					
Operating voltage	10~30V DC					
Voltage drop	< 1.5V					
Load Current, Max	150mA					
Current consumption	< 10mA					
Leakage current	< 0.01mA					
Switch frequency	1KHz	300Hz	1KHz	300Hz	1KHz	300Hz
Repeat accuracy	< 1.0% (Sr)					
Hysteresis	< 15% (Sr)					
Sensing surface material	ABS					
Operating Temperature	-25°C~+75°C					
Circuit Protection	Short circuit					
Degree of protection	IP67					
Model No.	TQF17-05□□	TQN17-08□□	TQF18-05□□	TQN18-08□□	TQF18C-05□□	TQN18C-08□□
	NPN Normally open		NPN Normally closed		PNP Normally open	
	NPN Normally open		NPN Normally closed		PNP Normally closed	

Dimensions (Unit:mm)

Q17

TQF17-05□□
TQN17-08□□

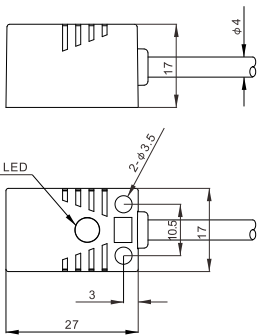

Q18

TQF18-05□□
TQN18-08□□

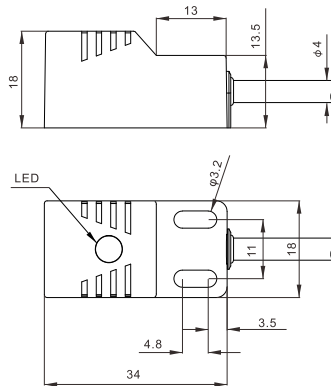

Q18C

TQF18C-05□□
TQN18C-08□□

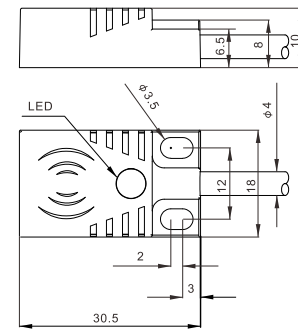

- Fiber Optic
- Slot Sensors
- Photoelectric
- Laser
- Proximity
- Displacement
- Magnetic
- Contact
- Area
- Ultrasonic
- Vision
- Code Readers
- Vibration
- Temperature
- Accessories

Guidance

Inductive sensors

- Standard distance
- Extended distance
- Long distance

Square

- Mini square
- Mini-cylindrical
- Short-body
- Ring-type
- Metal face
- Temperature
- IP69K high protection
- Analog output
- DC 2 wires

Capacitive sensors









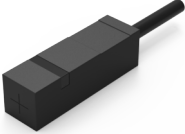
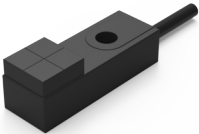
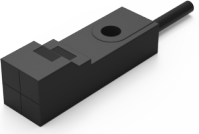

- Cylindrical
- Correction resistanc type
- Flat type
- Level detection

Mini-square











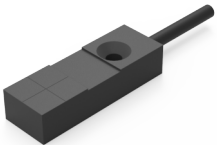
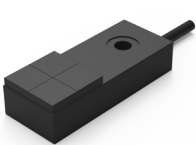

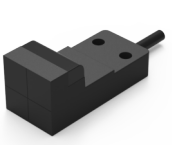

Pre-wired

Proximity



Appearance				
Mounting	Unshielded	Unshielded	Unshielded	Unshielded
Size	E06	E07	E08	E09
Sensing distance	1mm ± 15%	1mm ± 15%	2.5mm ± 10%	2.5mm ± 10%
Housing material	Plastic			
Operating voltage	10~30V DC(Ripple < 10%)			
Voltage drop	< 1.5V			
Load Current , Max	100mA		150mA	
Current consumption	< 10mA			
Leakage current	< 0.01mA			
Switch frequency	500Hz		800Hz	
Repeat accuracy	< 5% (Sr)		< 1% (Sr)	
Hysteresis	< 15% (Sr)			
Sensing surface material	PC			
Operating Temperature	-25°C~+75°C			
Circuit Protection	-		Short circuit	
Degree of protection	IP67			
Model No.	NPN Normally open	TEN06-01 	TEN07-01 	TEN08-2.5  
	Others	 :NPN Normally open	 :NPN Normally closed	 :PNP Normally open
			 :PNP Normally closed	 



Appearance				
Mounting	Unshielded	Unshielded	Unshielded	Unshielded
Size	E10	E12	E15	E16
Sensing distance	2.5mm/4mm ± 10%	4mm ± 10%	5mm/8mm ± 10%	5mm/8mm ± 10%
Housing material	Plastic			
Operating voltage	10~30V DC(Ripple < 10%)			
Voltage drop	< 1.5V			
Load Current, Max	150mA			
Current consumption	< 10mA			
Leakage current	< 0.01mA			
Switch frequency	800Hz/200Hz		1KHz/500Hz	
Repeat accuracy	< 5% (Sr)		< 1% (Sr)	
Hysteresis	< 15% (Sr)			
Sensing surface material	PC			
Operating Temperature	-25°C~+75°C			
Circuit Protection	Short circuit			
Degree of protection	IP67			
Model No.	NPN Normally open	TEN10-2.5  /TEN10-04 	TEN12-04 	TEN15-05  /TEN15-08 
	Others	 :NPN Normally open	 :NPN Normally closed	 :PNP Normally open
			 :PNP Normally closed	 /TEN16-08 

E06

TEN06-01□□

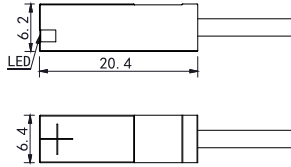

E07

TEN07-01□□

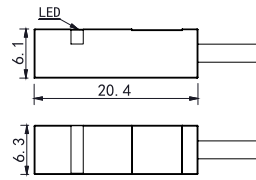

E08

TEN08-2.5/03□□

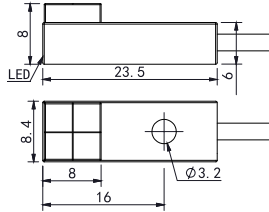

E09

TEN09-2.5/03□□

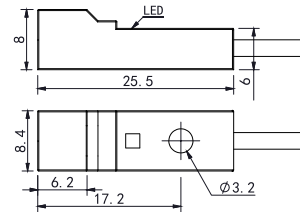

E10

TEN10-2.5/04□□

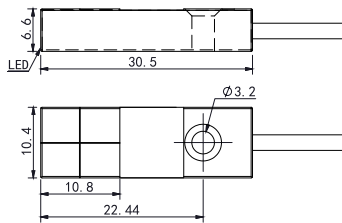

E12

TEN12-04□□

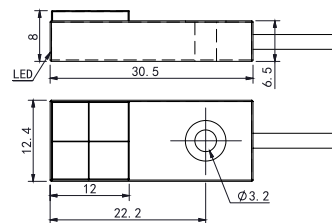

E15

TEN15-05/08□□

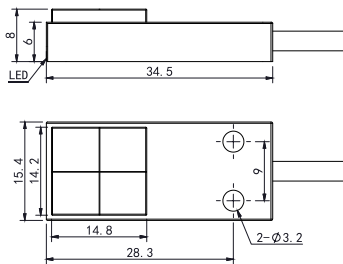

E16

TEN16-05/08□□

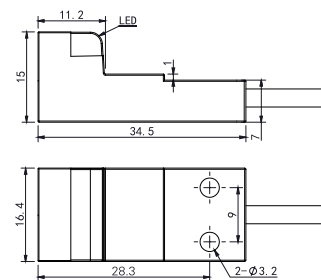

- Fiber Optic
- Slot Sensors
- Photoelectric
- Laser
- Proximity**
- Displacement
- Magnetic
- Contact
- Area
- Ultrasonic
- Vision
- Code Readers
- Vibration
- Temperature
- Accessories

Guidance

Inductive sensors

- Standard distance
- Extended distance
- Long distance
- Square

Mini square

- Mini-cylindrical
- Short-body
- Ring-type
- Metal face
- Temperature
- IP69K high protection
- Analog output
- DC 2 wires

Capacitive sensors

- Cylindrical
- Correction resistanc type
- Flat type
- Level detection

Mini-cylindrical

Pre-wired



Appearance		
Mounting	Shielded	
Size	φ 3	φ 4
Sensing distance	0.6mm/0.8mm/1.0mm ± 10%	0.8mm/1.0mm/1.2mm/1.5mm ± 10%
Housing material	Stainless steel	
Operating voltage	10~30V DC(Ripple < 10%)	
Voltage drop	< 1.5V	
Load Current, Max	100mA	150mA
Current consumption	< 10mA	
Leakage current	< 0.01mA	
Switch frequency	2KHz	
Repeat accuracy	< 1.0% (Sr)	
Hysteresis	< 15% (Sr)	
Sensing surface material	PA66	
Operating Temperature	-25°C~+75°C	
Degree of protection	IP67	
Model No.	NPN Normally open	TXF03-0.6N□/TXF03-0.8N□/TXF03-01N□ TXF04-0.8N□/TXF04-01N□/TXF04-1.2N□/TXF04-1.5N□
	Others	N□:NPN Normally open N□:NPN Normally closed P□:PNP Normally open P□:PNP Normally closed



Appearance		
Mounting	Shielded	
Size	M4	M5
Sensing distance	0.6mm/0.8mm/1.0mm ± 10%	0.8mm/1.0mm/1.2mm/1.5mm ± 10%
Housing material	Stainless steel	
Operating voltage	10~30V DC(Ripple < 10%)	
Voltage drop	< 1.5V	
Load Current,Max	100mA	150mA
Current consumption	< 10mA	
Leakage current	< 0.01mA	
Switch frequency	2KHz	
Repeat accuracy	< 5.0% (Sr)	
Hysteresis	< 15% (Sr)	
Sensing surface material	PA66	
Operating Temperature	-25°C~+75°C	
Degree of protection	IP67	
Model No.	NPN Normally open	TXFM4-0.6N□ / TXFM4-0.8N□ / TXFM4-01N□ TXF05-0.8N□ / TXF05-01N□ / TXF05-1.2N□ / TXF05-1.5N□
	Others	N□:NPN Normally open N□:NPN Normally closed P□:PNP Normally open P□:PNP Normally closed

φ3

TXF03-0.6/0.8/01□□

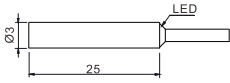

φ4

TXF04-0.8/01/1.2/1.5□□

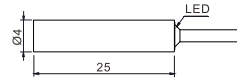

M4

TXFM4-0.6/0.8/01□□

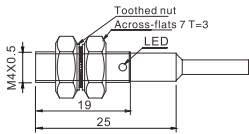

M5

TXF05-0.8/01/1.2/1.5□□

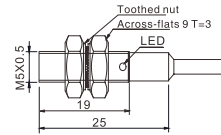

Fiber Optic

Slot Sensors

Photoelectric

Laser

Proximity

Displacement

Magnetic

Contact

Area

Ultrasonic

Vision

Code Readers

Vibration

Temperature

Accessories

Guidance

Inductive sensors

Standard distance

Extended distance

Long distance

Square

Mini square

Mini-cylindrical

Short-body

Ring-type

Metal face

Temperature

IP69K high protection

Analog output

DC 2 wires

Capacitive sensors

Cylindrical

Correction

resistance type

Flat type

Level detection

Short-body

Ultra Short Housing

Proximity



Appearance		
Mounting	Shielded	
Size	φ 6.5	φ 6.5Y
Sensing distance	1mm/2mm ± 10%	
Housing material	Stainless steel	
Operating voltage	10~30V DC(Ripple < 10%)	
Voltage drop	< 1.5V	
Load Current , Max	150mA	
Current consumption	< 10mA	
Leakage current	< 0.01mA	
Switch frequency	2KHz	
Repeat accuracy	< 1.0% (Sr)	
Hysteresis	< 15% (Sr)	
Sensing surface material	PBT	
Operating Temperature	-25°C~+75°C	
Circuit Protection	Short circuit	
Degree of protection	IP67	
Model No.	NPN Normally open	TSSF6.5-01 / TSSF6.5-02
	Others	:NPN Normally open :NPN Normally closed : PNP Normally open : PNP Normally closed
Model No.	NPN Normally open	TSSF6.5Y-01 / TSSF6.5Y-02
	Others	:NPN Normally open :NPN Normally closed : PNP Normally open : PNP Normally closed



Appearance		
Mounting	Shielded	
Size	M8	M12
Sensing distance	1mm/2mm ± 10%	2mm/4mm ± 10%
Housing material	Stainless steel	Nickle plated brass
Operating voltage	10~30V DC(Ripple < 10%)	
Voltage drop	< 1.5V	
Load Current , Max	150mA	
Current consumption	< 10mA	
Leakage current	< 0.01mA	
Switch frequency	2KHz	
Repeat accuracy	< 1.0% (Sr)	
Hysteresis	< 15% (Sr)	
Sensing surface material	PBT	
Operating Temperature	-25°C~+75°C	
Circuit Protection	Short circuit, except TSSF08-02 N O	
Degree of protection	IP67	
Model No.	NPN Normally open	TSSF08-01 / TSSF08-02
	Others	:NPN Normally open :NPN Normally closed : PNP Normally open : PNP Normally closed
Model No.	NPN Normally open	TSSF12-02 / TSSF12-04
	Others	:NPN Normally open :NPN Normally closed : PNP Normally open : PNP Normally closed

HOT



Appearance					
Mounting	Shielded				
Size	M8	M12	M18	M30	
Sensing distance	1mm/2mm ± 10%	2mm/4mm ± 10%	5mm/8mm ± 10%	10mm/16mm ± 10%	
Housing material	Stainless steel		Nickle plated brass		
Operating voltage	10~30V DC(Ripple < 10%)				
Voltage drop	< 1.5V				
Load Current, Max	150mA				
Current consumption	< 10mA				
Leakage current	< 0.01mA				
Switch frequency	2KHz	2KHz/1KHz	1KHz/500Hz	300Hz/150Hz	
Repeat accuracy	< 1.0% (Sr)				
Hysteresis	< 15% (Sr)				
Sensing surface material	PBT				
Operating Temperature	-25°C~+75°C				
Circuit Protection	Short circuit				
Degree of protection	IP67				
Model No.	NPN Normally open	TSF08-01[NO] / TSF08-02[NO]	TSF12-02[NO] / TSF12-04[NO]	TSF18-05[NO] / TSF18-08[NO]	TSF30-10[NO] / TSF30-16[NO]
	Others	[NO]:NPN Normally open	[NC]:NPN Normally closed	[PO]:PNP Normally open	[PC]:PNP Normally closed



Appearance					
Mounting	Unshielded				
Size	M8	M12	M18	M30	
Sensing distance	2mm/4mm ± 10%	4mm/8mm ± 10%	8mm/16mm ± 10%	15mm/25mm ± 10%	
Housing material	Stainless steel		Nickle plated brass		
Operating voltage	10~30V DC(Ripple < 10%)				
Voltage drop	< 1.5V				
Load Current, Max	150mA				
Current consumption	< 10mA		< 20mA		
Leakage current	< 0.01mA				
Switch frequency	2KHz/1KHz	1KHz/500Hz	500Hz/150Hz	150Hz/100Hz	
Repeat accuracy	< 1.0% (Sr)				
Hysteresis	< 15% (Sr)				
Sensing surface material	PBT				
Operating Temperature	-25°C~+75°C				
Circuit Protection	Short circuit				
Degree of protection	IP67				
Model No.	NPN Normally open	TSN08-02[NO] / TSN08-04[NO]	TSN12-04[NO] / TSN12-08[NO]	TSN18-08[NO] / TSN18-16[NO]	TSN30-15[NO] / TSN30-25[NO]
	Others	[NO]:NPN Normally open	[NC]:NPN Normally closed	[PO]:PNP Normally open	[PC]:PNP Normally closed

Fiber Optic
Slot Sensors
Photoelectric
Laser
Proximity
Displacement
Magnetic
Contact
Area
Ultrasonic
Vision
Code Readers
Vibration
Temperature
Accessories

Guidance

Inductive sensors

Standard distance
Extended distance
Long distance
Square
Mini square
Mini-cylindrical
Short-body
Ring-type
Metal face
Temperature
IP69K high protection
Analog output
DC 2 wires

Capacitive sensors

Cylindrical
Correction
resistance type
Flat type
Level detection

Short-body

Extra Shot Outer Casing-Dimensions (Unit:mm)

φ6.5

TSSF6.5-01/02 □ □

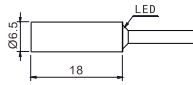

φ6.5Y

TSSF6.5Y-01/02 □ □

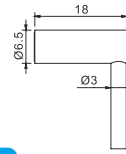

M8

TSSF08-01/02 □ □

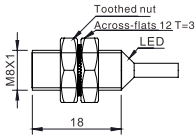

M12

TSSF12-02/04 □ □

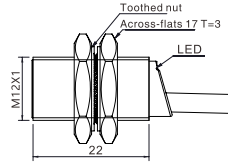

General-Dimensions (Unit:mm)

M8

TSF08-01/02 □ □

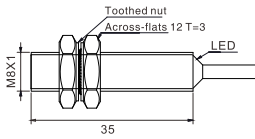

TSN08-02/04 □ □

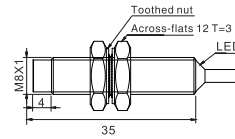

M12

TSF12-02/04 □ □

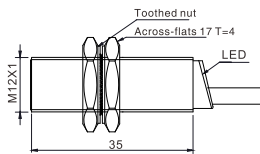

TSN12-04/08 □ □

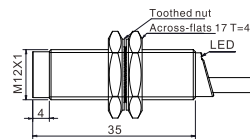

M18

TSF18-05/08 □ □

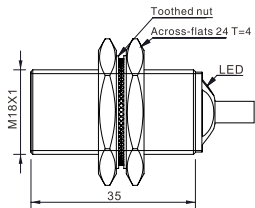

TSN18-08/16 □ □

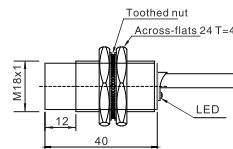

M30

TSF30-10/16 □ □

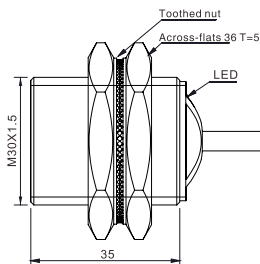

TSN30-15/25 □ □

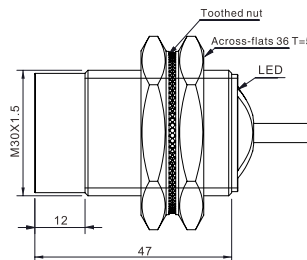

- Fiber Optic
- Slot Sensors
- Photoelectric
- Laser
- Proximity**
- Displacement
- Magnetic
- Contact
- Area
- Ultrasonic
- Vision
- Code Readers
- Vibration
- Temperature
- Accessories

- Guidance**
- Inductive sensors
 - Standard distance
 - Extended distance
 - Long distance
 - Square
 - Mini square
 - Mini-cylindrical
- Short-body**
- Ring-type
- Metal face
- Temperature
- IP69K high protection
- Analog output
- DC 2 wires
- Capacitive sensors
 - Cylindrical
 - Correction resistanc type
 - Flat type
 - Level detection



Appearance

Size	H10	H15	H21	H43
Hole diameter	10.5mm	15.5mm	22.5mm	43.5mm
Hole height	20mm			
Housing material	ABS			
Operating voltage	10~30V DC (Ripple < 10%)			
Voltage drop	< 1.5V			
Load Current, Max	150mA			
Current consumption	< 15mA			
Leakage current	< 10mA			
Switch frequency	2KHz	1.5KHz	1KHz	500Hz
Min. detectable object	D=2.5mm; L=4mm	D=3mm; L=6mm	D=6mm; L=12mm	D=9mm; L=18mm
Repeat accuracy	< 2.0% (Sr)			
Hysteresis	< 15% (Sr)			
Sensing surface material	PBT			
Operating Temperature	-25°C ~ +75°C			
Circuit Protection	Short circuit; Reverse polarity			
Degree of protection	IP67			
Model No.	TH10-20	TH15-20	TH21-20	TH43-20

: NPN Normally open : NPN Normally closed : PNP Normally open : PNP Normally closed

Dimensions (Unit:mm)

H10

TH10-20

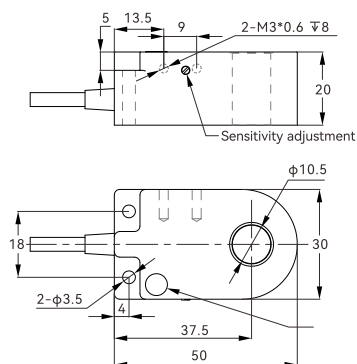

H15

TH15-20

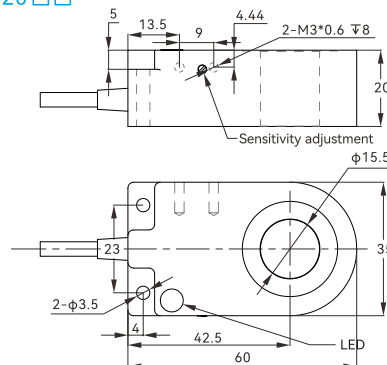

H21

TH21-20

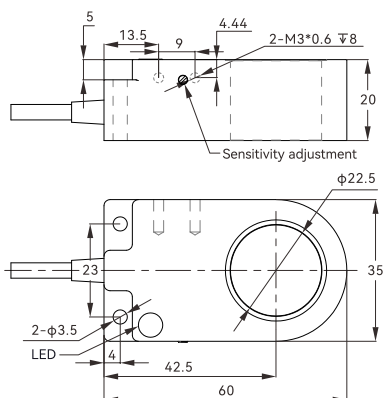

H43

TH43-20

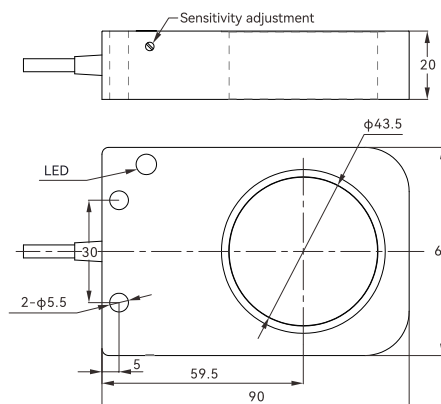

Fiber Optic

Slot Sensors

Photoelectric

Laser

Proximity

Displacement

Magnetic

Contact

Area

Ultrasonic

Vision

Code Readers

Vibration

Temperature

Accessories

Guidance

Inductive sensors

Standard distance

Extended distance

Long distance

Square

Mini square

Mini-cylindrical

Short-body

Ring-type

Metal face

Temperature

IP69K high protection

Analog output

DC 2 wires

Capacitive sensors

Cylindrical

Correction

resistanc type

Flat type

Level detection

Pre-wired



Appearance					
Mounting	Shielded				
Size	M8	M12	M18	M30	
Sensing distance	1mm/2mm ± 10%	2mm/4mm ± 10%	5mm/8mm ± 10%	10mm/16mm ± 10%	
Housing material	Stainless steel				
Operating voltage	10~30V DC(Ripple < 10%)				
Voltage drop	< 1.5V				
Load Current, Max	150mA				
Current consumption	< 10mA				
Leakage current	< 0.01mA				
Switch frequency	2KHz/1KHz		1KHz/500Hz	300Hz/150Hz	
Repeat accuracy	< 1.0% (Sr)				
Hysteresis	< 15% (Sr)				
Sensing surface material	Stainless steel				
Operating Temperature	-25°C~+75°C				
Circuit protection	Short circuit				
Degree of protection	IP67				
Model No.	NPN Normally open	TMF08-01 NCO /TMF08-02 NCO	TMF12-02 NCO /TMF12-04 NCO	TMF18-05 NCO /TMF18-08 NCO	TMF30-10 NCO /TMF30-16 NCO
	Others	NCO :NPN Normally open	NCC :NPN Normally closed	PO :PNP Normally open	PC :PNP Normally closed



Appearance					
Mounting	Unshielded				
Size	M8	M12	M18	M30	
Sensing distance	2mm/3mm ± 10%	4mm/8mm ± 10%	8mm/16mm ± 10%	15mm/25mm ± 10%	
Housing material	Stainless steel				
Operating voltage	10~30V DC(Ripple < 10%)				
Voltage drop	< 1.5V				
Load Current, Max	150mA				
Current consumption	< 10mA				
Leakage current	< 0.01mA				
Switch frequency	2KHz/1KHz		1KHz/500Hz	500Hz/150Hz	
Repeat accuracy	< 1.0% (Sr)				
Hysteresis	< 15% (Sr)				
Sensing surface material	Stainless steel				
Operating Temperature	-25°C~+75°C				
Circuit protection	Short circuit				
Degree of protection	IP67				
Model No.	NPN Normally open	TMN08-02 NCO /TMN08-03 NCO	TMN12-04 NCO /TMN12-08 NCO	TMN18-08 NCO /TMN18-16 NCO	TMN30-15 NCO /TMN30-25 NCO
	Others	NCO :NPN Normally open	NCC :NPN Normally closed	PO :PNP Normally open	PC :PNP Normally closed

M8

TMF08-01/02 □□

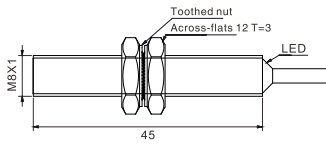

TMN08-02/03 □□

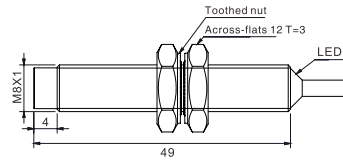

M12

TMF12-02/04 □□

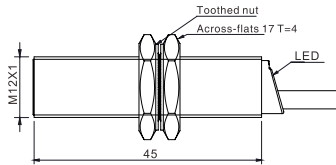

TMN12-04/08 □□

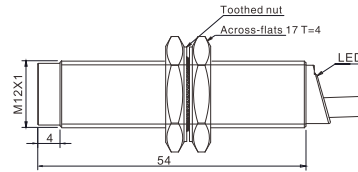

M18

TMF18-05/08 □□

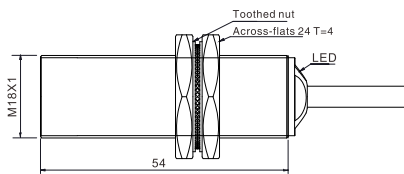

TMN18-08/16 □□

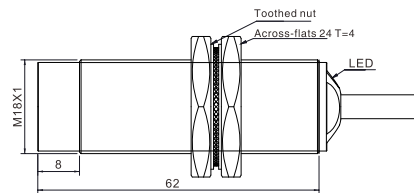

M30

TMF30-10/16 □□

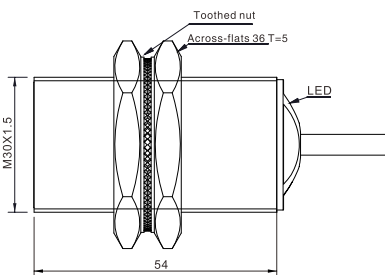

TMN30-15/25 □□

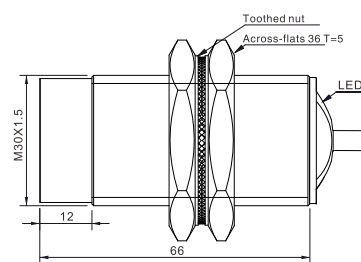

- Fiber Optic
- Slot Sensors
- Photoelectric
- Laser
- Proximity**
- Displacement
- Magnetic
- Contact
- Area
- Ultrasonic
- Vision
- Code Readers
- Vibration
- Temperature
- Accessories

Guidance

Inductive sensors

- Standard distance
- Extended distance
- Long distance
- Square
- Mini square
- Mini-cylindrical
- Short-body
- Ring-type

Metal face

- Temperature
- IP69K high protection
- Analog output
- DC 2 wires

Capacitive sensors

- Cylindrical
- Correction resistanc type
- Flat type
- Level detection

Temperature Resistance

High Temperature (120°C) Resistance Pre-wired Type

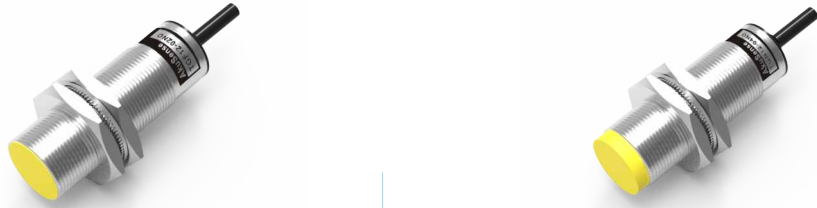

Appearance	Shielded			Unshielded			
Mounting	Shielded			Unshielded			
Size	M12	M18	M30	M12	M18	M30	
Sensing distance	2mm ± 10%	5mm ± 10%	10mm ± 10%	4mm ± 10%	8mm ± 10%	15mm ± 10%	
Housing material	Nickel copper alloy						
Operating voltage	10~30V DC(Ripple < 10%)						
Voltage drop	< 2.5V						
Load Current, Max	100mA						
Current consumption	< 15mA						
Hysteresis	1~20%						
Repeat accuracy	< 5%						
Response frequency	1500Hz	1000Hz	500Hz	1000Hz	800Hz	300Hz	
Indicator	Yellow LED						
Ambient temperature	-25°C~+120°C						
Ambient humidity	35~95% RH						
Circuit protection	Reverse polarity; Surge protection						
Degree of protection	IP67						
Model No.	NPN Normally open	TGF12-02N□	TGF18-05N□	TGF30-10N□	TGN12-04N□	TGN18-08N□ (HOT)	TGN30-15N□
	Others	N□:NPN Normally open		N□:NPN Normally closed	P□:PNP Normally open	P□:PNP Normally closed	

High Temperature (220°C) Resistance Pre-wired Type



Appearance	Shielded			
Mounting	Shielded			
Housing size	M12	M18	M30	
Sensing distance	2mm ± 10%	5mm ± 10%	10mm ± 10%	
Housing material	Nickel copper alloy			
Operating voltage	10~30V DC			
Voltage drop	< 1.8V			
Load current	External			
Current consumption	< 25mA(24V)			
Switch frequency	500Hz/220°C	500Hz/230°C	200Hz/230°C	
Repeat accuracy	< 3.0% (Sr)			
Hysteresis	3~15% (Sr)			
Sensing surface material	PEEK			
Ambient temperature	-25~+230°C			
Degree of protection	IP66			
Interface	PTFE Cable/2m; 3*0.34mm ²			
Model No.	NPN Normally open	TGF12-02NO2	TGF18-05NO2	TGF30-10NO2
	PNP Normally open	TGF12-02PO2	TGF18-05PO2	TGF30-10PO2

M12

TGF12-02□□

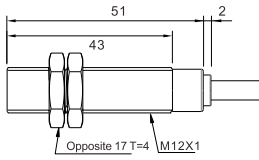

TGN12-04□□

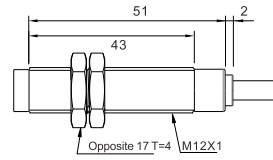

TGF12-02□□2

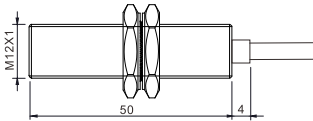

M18

TGF18-05□□

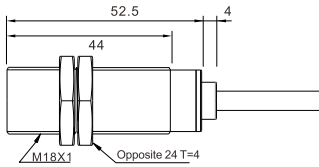

TGN18-08□□

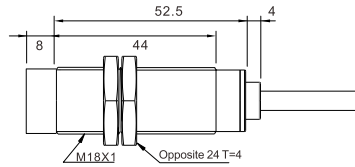

TGF18-05□□2

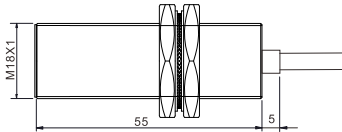

M30

TGF30-10□□

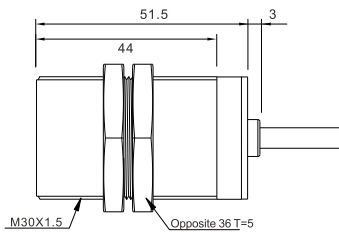

TGN30-15□□

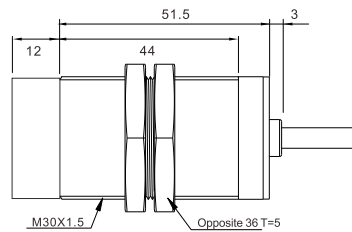

TGF30-10□□2

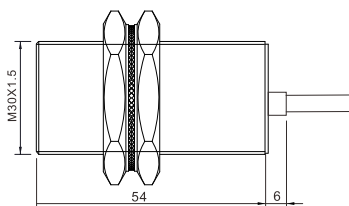

- Fiber Optic
- Slot Sensors
- Photoelectric
- Laser
- Proximity**
- Displacement
- Magnetic
- Contact
- Area
- Ultrasonic
- Vision
- Code Readers
- Vibration
- Temperature
- Accessories

Guidance

Inductive sensors

- Standard distance
- Extended distance
- Long distance
- Square

Mini square

Mini-cylindrical

Short-body

Ring-type

Metal face

Temperature

IP69K high protection

Analog output

DC 2 wires

Capacitive sensors

Cylindrical

Correction resistanc type

Flat type

Level detection

IP69K High Protection

TP Series

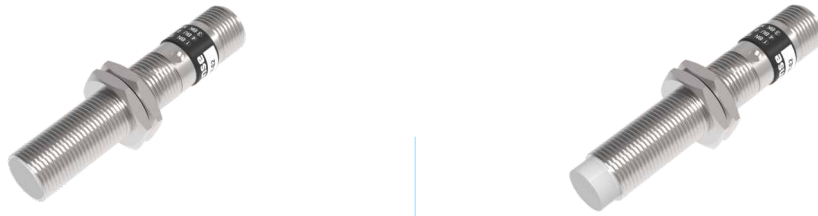

Appearance	Shielded		Unshielded		
Mounting	2mm		4mm		
Sensing distance	0~1.62mm		0~3.24mm		
Working distance	0~1.62mm		0~6.5mm		
Hysteresis	1~20%				
Standard target	12 x 12mm FE360		24 x 24mm FE360		
Repeatability	5%				
Operating	10~30V DC				
Output type	NPN or PNP-NO+NC or NO				
Maximum ripple content	≤ 10%				
Output current	≤ 200mA				
Output voltage drop	≤ 2V				
No-load current	≤ 15mA				
Leakage current	≤ 15uA				
operating frequency	2kHz				
Start delay	50ms				
Ambient temperature range	-40°C~+80°C in a short time (within 15 seconds) up to 100°C 10%				
Thermal drift	10%				
Shock and vibration	IEC 60947-5-5/7.4				
Weight	30g				
LEDs	NO output status/without led -25°C~+110°C				
Degree of protection	IP67,IP68(1m,7days);IP69K (in line with DIN 40050-9 standard)				
Electromagnetic compatibility/EMC	Comply with EMC directive requirements and comply with IEC 60947-5-2 specification				
Housing material	Stainless steel				
Sensing surface material	PPS (FDA certification)				
Connection method	M12 connector with gold-plated pins				
Tightening torque	25Nm				
Model No	NPN	TPF12-02NR-E2	TPF12-04NR-E2	TPN12-04NR-E2	TPN12-08NR-E2
	PNP	TPF12-02PR-E2	TPF12-04PR-E2	TPN12-04PR-E2	TPN12-08PR-E2

Dimensions (Unit:mm)

TPF12-02NR-E2(PR)
TPF12-04NR-E2(PR)

TPN12-04NR-E2(PR)
TPN12-08NR-E2(PR)

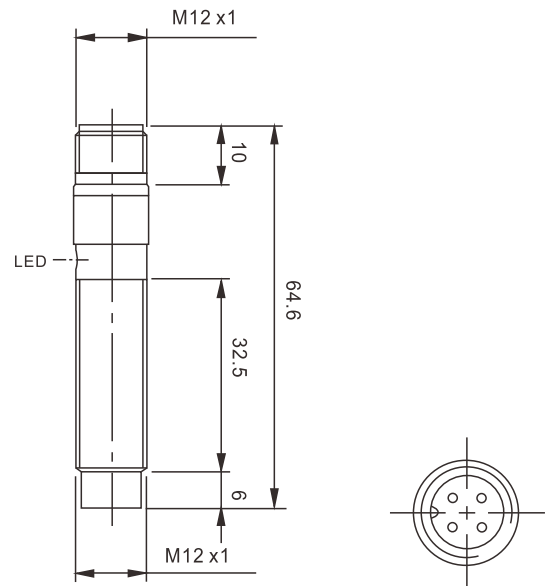
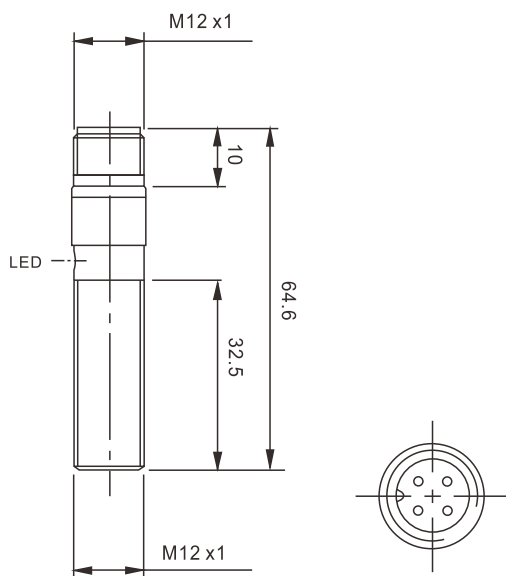



Appearance	Shielded		Unshielded		
Mounting	5mm		8mm		
Sensing distance	0~4mm		0~6.5mm		
Working distance			12mm		
Hysteresis			1~20%		
Standard target	18 × 18mm FE360		36 × 36mm FE360		
Repeatability			5%		
Operating Voltage			10~30V DC		
Output type			NPN or PNP-NO+NC or NO		
Maximum ripple content			≤ 10%		
Output current			≤ 200mA		
Output voltage drop			≤ 2V		
No-load current			≤ 15mA		
Leakage current			≤ 10uA		
Operating frequency			15kHz		
Start delay			50ms		
Ambient temperature range			-40°C~+80°C in a short time (within 15 seconds) up to 100°C 10%		
Thermal drift			10%		
Shock and vibration			IEC 60947-5-5/7.4		
Weight			30g		
LEDs			NO output status/without led -25°C~+110°C		
Degree of protection			IP67, IP68(1m, 7days); IP69K (in line with DIN 40050-9 standard)		
Electromagnetic compatibility/EMC			Comply with EMC directive requirements and comply with IEC 60947-5-2 specification		
Housing material			Stainless steel		
Sensing surface material			PPS (FDA certification)		
Connection method			M12 connector with gold-plated pins		
Tightening torque			25Nm		
Model No	NPN	TPF18-05NR-E2	TPF18-08NR-E2	TPN18-08NR-E2	TPN18-12NR-E2
	PNP	TPF18-05PR-E2	TPF18-08PR-E2	TPN18-08PR-E2	TPN18-12PR-E2

Dimensions (Unit:mm)

TPF18-05NR-E2(PR)
TPF18-08NR-E2(PR)

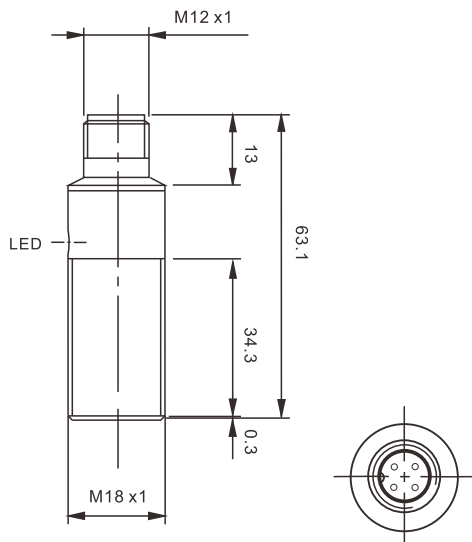

TPN18-08NR-E2(PR)
TPN18-12NR-E2(PR)

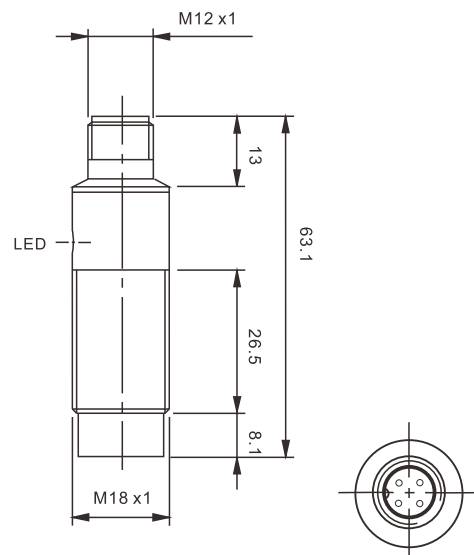

- Fiber Optic
- Slot Sensors
- Photoelectric
- Laser
- Proximity**
- Displacement
- Magnetic
- Contact
- Area
- Ultrasonic
- Vision
- Code Readers
- Vibration
- Temperature
- Accessories

Guidance

Inductive sensors

- Standard distance
- Extended distance
- Long distance
- Square
- Mini square
- Mini-cylindrical
- Short-body
- Ring-type
- Metal face
- Temperature
- IP69K high protection**
- Analog output
- DC 2 wires

Capacitive sensors

- Cylindrical
- Correction resistanc type
- Flat type
- Level detection

Analog Output

Pre-wired

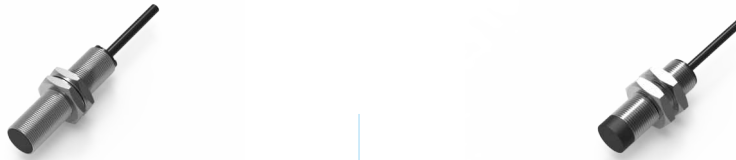

Appearance

Mounting	Shielded			Unshielded			
Size	M12	M18	M30	M12	M18	M30	
Sensing distance	0.1~3mm ± 10%	1~4mm ± 10%	5~10mm ± 10%	0.1~4mm ± 10%	1~7mm ± 10%	7~14mm ± 10%	
Housing material	Nickel copper alloy						
Operating voltage	18~30V DC(Ripple < 10%)						
Current consumption	< 15mA						
Linear	< 5%						
Switch frequency	100Hz						
Repeat accuracy	0.02mm						
Current output	4~20mA/≤200Ω	0~20mA/≤200Ω		4~20mA/≤400Ω	0~20mA/≤200Ω		
Voltage output	0~10VDC/≥4.7KΩ						
Output type	PNP-Analog						
Sensing surface material	PBT						
Ambient temperature	-25°C~+75°C						
Circuit protection	Reverse polarity						
Degree of protection	IP67						
Model No.	Current output	TAF12-03PA	TAF18-04PA	TAF30-10PA	TAN12-04PA	TAN18-07PA	TAN30-14PA
	Volage output	TAF12-03PV	TAF18-04PV	TAF30-10PV	TAN12-04PV	TAN18-07PV	TAN30-14PV

Dimensions (Unit:mm)

M12

TAF12-03 □□

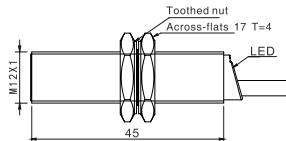

TAN12-04 □□

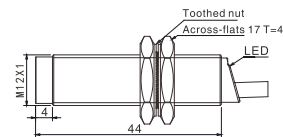

M18

TAF18-04 □□

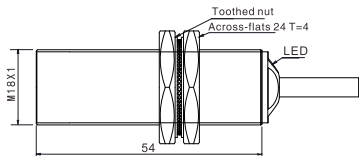

TAN18-07 □□

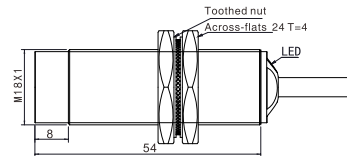



M30

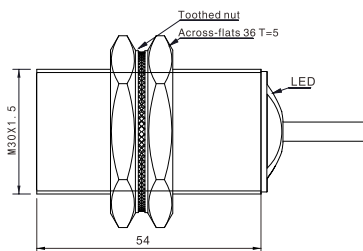

TAF30-10 □□

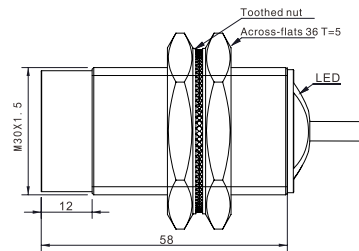

TAN30-14 □□



Appearance						
Mounting	Shielded					
Size	φ 6.5	M8	M12	M18	M30	
Sensing distance	1 mm/2mm ± 10%	1 mm/2mm ± 10%	2mm/4mm ± 10%	5mm/8mm ± 10%	10mm/16mm ± 10%	
Housing material	Stainless steel		Nickel copper alloy			
Operating voltage	10~30V DC(Ripple < 10%)		10~60V DC(Ripple < 10%)			
Operating current	3~100mA					
Leakage current	< 0.8mA					
Voltage drop	< 6V/ < 4V					
Circuit protection	Short circuit					
Over-load current	> 120mA					
Switch frequency	2KHz		1KHz	500Hz		
Hysteresis	15%					
Temperature drift	10%					
Repeat accuracy	< 2%					
Operating Temperature	-25°C~+75°C					
Sensing surface material	PBT					
Model No.	Normally open	TDF6.5-01HO/TDF6.5-02HO	TDF08-01HO/TDF08-02HO	TDF12-02HO/TDF12-04HO	TDF18-05HO/TDF18-08HO	TDF30-10HO/TDF30-16HO
	Normally close	TDF6.5-01HC/TDF6.5-02HC	TDF08-01HC/TDF08-02HC	TDF12-02HC/TDF12-04HC	TDF18-05HC/TDF18-08HC	TDF30-10HC/TDF30-16HC

Appearance						
Mounting	Unshielded					
Size	φ 6.5	M8	M12	M18	M30	
Sensing distance	2mm/4mm ± 10%	2mm/4mm ± 10%	4mm/8mm ± 10%	8mm/16mm ± 10%	15mm/25mm ± 10%	
Housing material	Stainless steel		Nickle plated brass			
Operating voltage	10~30V DC(Ripple < 10%)		10~60V DC(Ripple < 10%)			
Operating current	3~100mA					
Leakage current	< 0.8mA					
Voltage drop	< 6V/ < 4V					
Circuit protection	Short circuit					
Over-load current	> 120mA					
Switch frequency	2KHz		1KHz	500Hz	200Hz	
Hysteresis	15%					
Temperature drift	10%					
Repeat accuracy	< 2%					
Operating Temperature	-25°C~+75°C					
Sensing surface material	PBT					
Model No.	Normally open	TDN6.5-02HO/TDN6.5-04HO	TDN08-02HO/TDN08-04HO	TDN12-04HO/TDN12-08HO	TDN18-08HO/TDN18-16HO	TDN30-15HO/TDN30-25HO
	Normally close	TDN6.5-02HC/TDN6.5-04HC	TDN08-02HC/TDN08-04HC	TDN12-04HC/TDN12-08HC	TDN18-08HC/TDN18-16HC	TDN30-15HC/TDN30-25HC

- Fiber Optic
- Slot Sensors
- Photoelectric
- Laser
- Proximity**
- Displacement
- Magnetic
- Contact
- Area
- Ultrasonic
- Vision
- Code Readers
- Vibration
- Temperature
- Accessories

Guidance

Inductive sensors

- Standard distance
- Extended distance
- Long distance
- Square
- Mini square
- Mini-cylindrical
- Short-body
- Ring-type
- Metal face
- Temperature
- IP69K high protection
- Analog output**
- DC 2 wires

Capacitive sensors

- Cylindrical
- Correction resistanc type
- Flat type
- Level detection

DC 2-wire

Dimensions (Unit:mm)

φ6.5

TDF6.5-01/02 □□

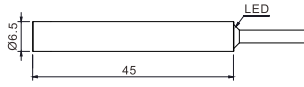

TDN6.5-02/04 □□

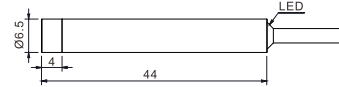

M8

TDF08-01/02 □□

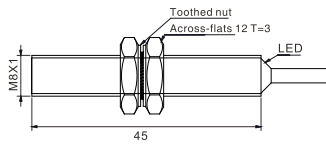

TDN08-02/04 □□

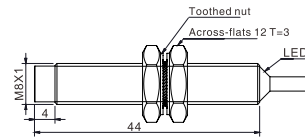

M12

TDF12-02/04 □□

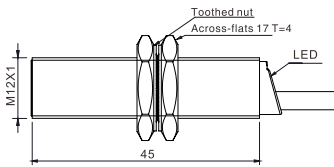

TDN12-04/08 □□

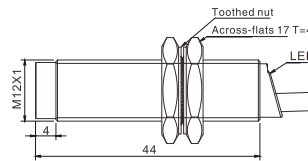

M18

TDF18-05/08 □□

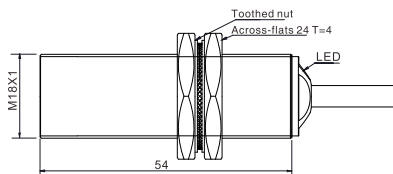

TDN18-08 □□

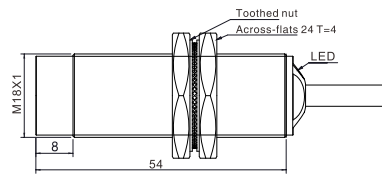

TDN18-16 □□

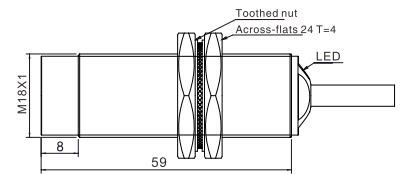

M30

TDF30-10/16 □□

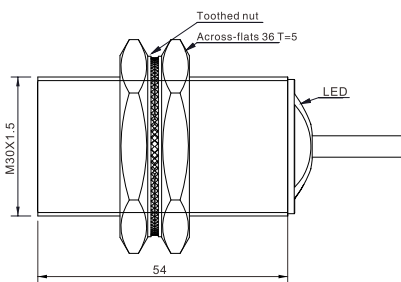

TDN30-15 □□

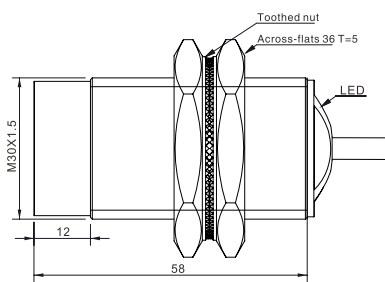

TDN30-25 □□

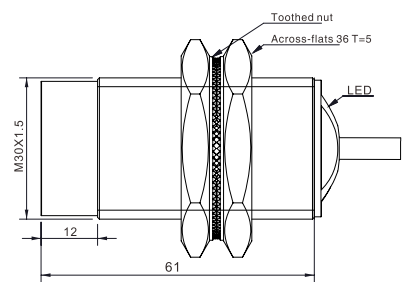

- Fiber Optic
- Slot Sensors
- Photoelectric
- Laser
- Proximity**
- Displacement
- Magnetic
- Contact
- Area
- Ultrasonic
- Vision
- Code Readers
- Vibration
- Temperature
- Accessories

Guidance

- Inductive sensors**
- Standard distance
- Extended distance
- Long distance
- Square
- Mini square
- Mini-cylindrical
- Short-body
- Ring-type
- Metal face
- Temperature

- IP69K high protection
- Analog output
- DC 2 wires**

- Capacitive sensors**
- Cylindrical
- Correction resistant type
- Flat type
- Level detection

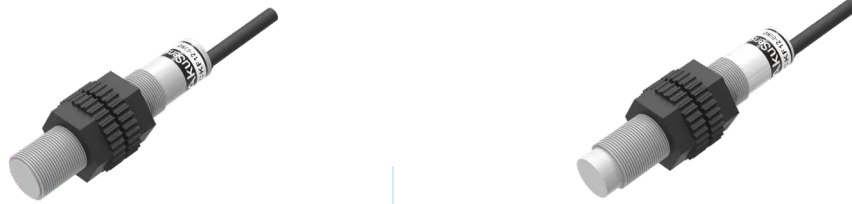

Appearance	Shielded			Unshielded			
Mounting	M12	M18	M30	M12	M18	M30	
Sensing distance	1~3mm adjustable	2~8mm adjustable	2~20mm adjustable	1~6mm adjustable	2~15mm adjustable	2~30mm adjustable	
Housing material	PBT						
Operating voltage	10~30V DC(Ripple < 10%)						
Voltage drop	< 2V						
Load Current, Max	150mA	300mA		150mA	300mA		
Current consumption	< 10mA						
Leakage current	< 0.01mA						
Switch frequency	100Hz						
Repeat accuracy	< 5% (Sr)						
Hysteresis	< 15% (Sr)						
Sensing surface material	PBT						
Operating Temperature	-25°C~+75°C						
Circuit protection	Short circuit						
Degree of protection	IP67						
Model No.	NPN Normally open	CKF12-03 NO	CKF18-08 NO	CKF30-20 NO	CKN12-06 NO	CKN18-15 NO	CKN30-30 NO
Others	NO :NPN Normally open		NC :NPN Normally closed		PO :PNP Normally open		PC :PNP Normally closed

Dimensions-Plastic Shells (Unit:mm)

M12

CKF12-03 □□

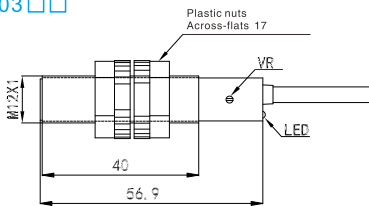

CKN12-06 □□

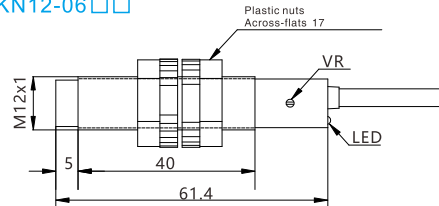

M18

CKF18-08 □□

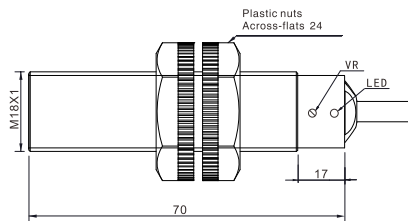

CKN18-15 □□

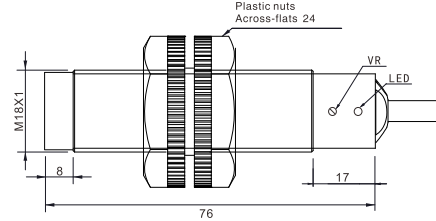

M30

CKF30-20 □□

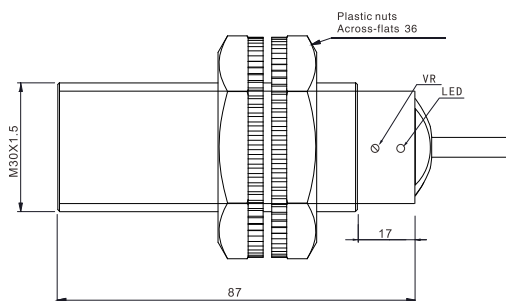

CKN30-30 □□

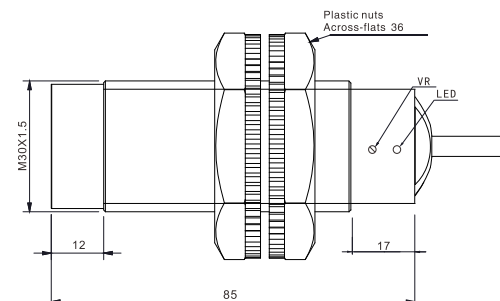

- Fiber Optic
- Slot Sensors
- Photoelectric
- Laser
- Proximity**
- Displacement
- Magnetic
- Contact
- Area
- Ultrasonic
- Vision
- Code Readers
- Vibration
- Temperature
- Accessories

Guidance

Inductive sensors

- Standard distance
- Extended distance
- Long distance
- Square
- Mini square
- Mini-cylindrical
- Short-body
- Ring-type
- Metal face
- Temperature
- IP69K high protection
- Analog output
- DC 2 wires

Capacitive sensors

- Cylindrical**
- Correction resistanc type
- Flat type
- Level detection

Corrosion Resistance



Corrosion resistance

Appearance

Mounting	Shielded
Size	M18
Sensing distance	1~10mm adjustable
Detectable objects	Metal、Water、Oil、Glass、Plastic、Paper
Operating voltage	12~24V DC(Ripple < 10%)
Voltage drop	< 1.5V
Load Current, Max	100mA
Current consumption	< 22mA
Leakage current	< 1.1mA
Response time	≤ 14ms
Isolation impedance	≥ 20M Ω (500V DC)
Hysteresis	< 10% (Sr)
Insulation withstand voltage	AC 1000V 60Hz lasts 60 Sec
Operating temperature	-20℃~+60℃
Degree of protection	IP66
Connection	φ 4.2X2m 4 core cable
Weight	≈ 78g
Model No.	CWF18-10NP (NPN NO/NC PNP PC/PO)

Dimensions

Unit: mm

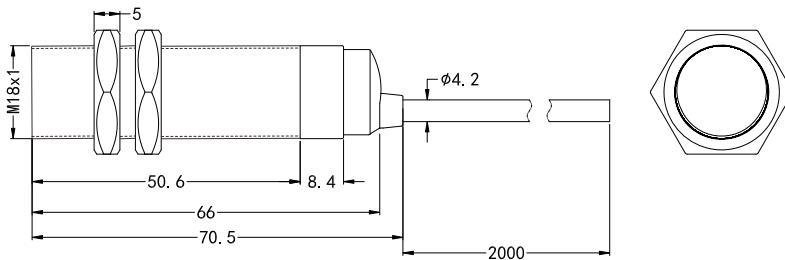

Circuit diagram

Method 1:

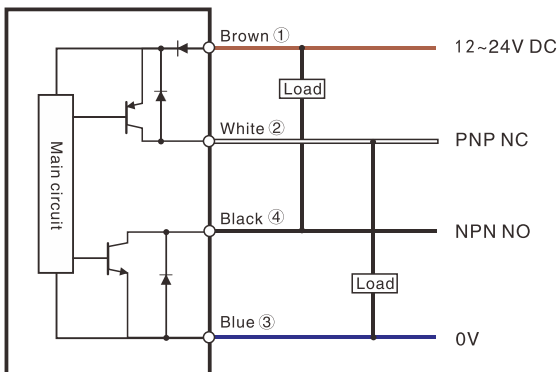

Method 2:

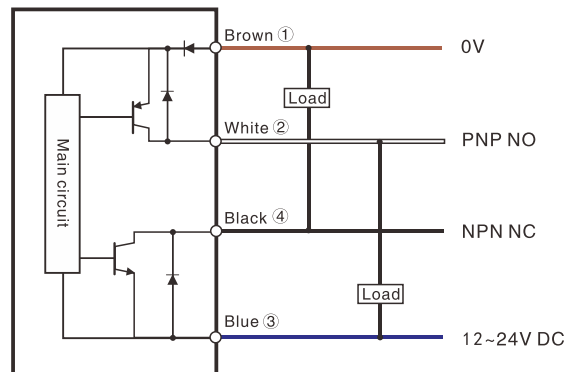

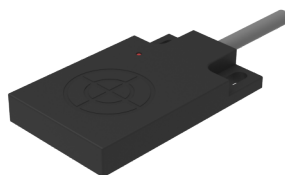

Appearance		
Sensing distance	5mm(adjustable)	10mm(adjustable)
Housing material	Plastic, black/blue	
Operating voltage	24V DC(Ripple < 10%)	
Voltage drop	≤ 1.5V@1L=50mA	
Output type	NPN or PNP –NO/NC	
Load Current, Max	≤ 50mA	
Current consumption	≤ 10mA	
Switch frequency	100Hz	
Repeat accuracy	< 5%	
Operating Temperature	0°C~+60°C	
Storage temperature	-30°C~+75°C	
Temperature drift	≤ 20%	
Circuit protection	Reverse polarity, Over voltage pulse protection, Short circuit	
Degree of protection	IP67	
Model No.	NPN Normally open	CQ07-05 NO
	Others	NO :NPN Normally open NC :NPN Normally closed PO :PNP Normally open PC :PNP Normally closed
		CQ07-10 NO

- Fiber Optic
- Slot Sensors
- Photoelectric
- Laser
- Proximity**
- Displacement
- Magnetic
- Contact
- Area
- Ultrasonic
- Vision
- Code Readers
- Vibration
- Temperature
- Accessories

Dimensions (Unit:mm)

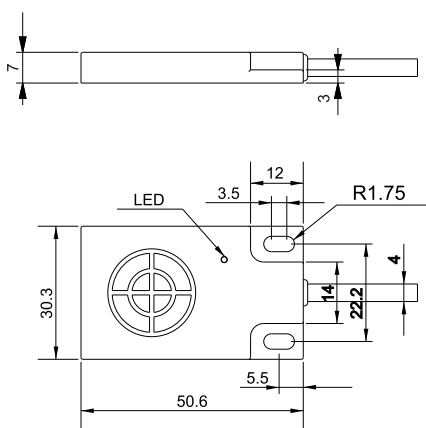

Guidance

Inductive sensors

- Standard distance
- Extended distance
- Long distance
- Square
- Mini square
- Mini-cylindrical
- Short-body
- Ring-type
- Metal face
- Temperature
- IP69K high protection
- Analog output
- DC 2 wires

Capacitive sensors

- Cylindrical
- Correction resistanc type
- Flat type**
- Level detection

Flat Type

CQ07 Series

Proximity



Appearance

Sensing distance	8mm adjustable
Mouting	shield
Output Indicator	Red LED
Repetition accuracy	$\leq 1\% S, R$
Hysteresis	$\leq 10\%$
Switching frequency	35Hz
Operating Voltage	10~30V
Residual voltage	$\leq 1.5V$
Current consumption	$\leq 10mA$
Load current	$\leq 150mA$
Leakage current	$< 0.01mA$
Temperature drift	$\leq 20\%$
Circuit protection	Reverse polarity protection, surge protection, short circuit protection
Insulation resistance	$\geq 50M \Omega$
Voltage resistance	AC500V 50/60Hz 1min Between the charging section as a whole and the housing
Housing material	PBT
Protection level	IP66
Operating temperature	-10 ~ 55°C
Storage temperature	-20 ~ 75°C
Ambient Humidity	35% ~ 85%
Vibration resistance	10~55Hz Dual Amplitude 1.5mm, 2 hours each in XYZ direction
Impact resistance	10G, 3 times each in XYZ direction
Connection method	2M/3 core cable
Conformity	EIC60947-5-2
Model NO.	NPN normally open CQ07-08N□
	Others □ :NPN Normally open □ :NPN Normally closed □ :PNP Normally open □ :PNP Normally closed

Dimensions (Unit:mm)

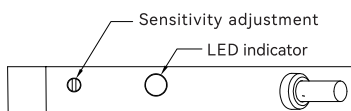
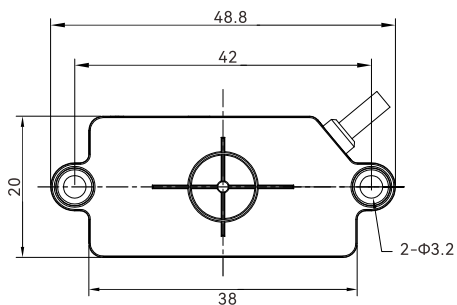



Appearance

Mounting	Unshielded	
Operating voltage	10~30V DC	
Load Current, Max	150mA	
Voltage drop	< 2.5V	
Current consumption	< 15mA	
Hysteresis	3~20%	
Repeat accuracy	< 3%	
Switch frequency	20Hz	
Indicator	Yellow LED	
Material	Nonmetal	
Pipeline	External diameter	$\phi 8 \sim \phi 11$
	Wall thickness	$\phi 12 \sim \phi 26$
		< 1mm
Circuit protection	Reverse polarity/Short circuit	
Ambient temperature	-25°C~+75°C	
Degree of protection	IP67	
Housing material	PBT	
Connection	2mPVC Cable	
Model No.	NPN Normally open	CE15-13 NO
	Others	CE30-26 NO (HOT)
	NO :NPN Normally open NC :NPN Normally closed PO :PNP Normally open PC :PNP Normally closed	

- Fiber Optic
- Slot Sensors
- Photoelectric
- Laser
- Proximity**
- Displacement
- Magnetic
- Contact
- Area
- Ultrasonic
- Vision
- Code Readers
- Vibration
- Temperature
- Accessories

Dimensions (Unit:mm)

CE15

CE15-13 □□

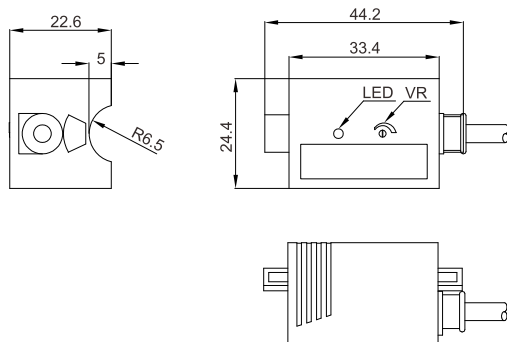

CE30

CE30-26 □□

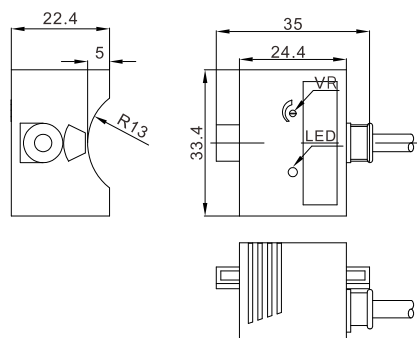

Guidance

Inductive sensors

- Standard distance
- Extended distance
- Long distance
- Square
- Mini square
- Mini-cylindrical
- Short-body
- Ring-type
- Metal face
- Temperature
- IP69K high protection
- Analog output
- DC 2 wires

Capacitive sensors

- Cylindrical
- Correction resistanc type
- Flat type
- Level detection**